



TRT 100US
100 US_t capacity class
Rough terrain crane
Datasheet
imperial



TRT 100US

WORKS FOR YOU.™

CONTENTS

TRT 100US

INDICE

	Page · Página:
Key · Lejenda	3
Highlights · Características destacadas	4
Weights · Pesos	5
Dimensions · Dimensiones	6-7
Steering Radii · Radios de dirección	8-9
Range Graph – Main Boom · Diagrama de carga	10
Load Chart – Main Boom. US STANDARD ASME B30.5 · Tabla de carga	11-17
Range Graph – Jib · Diagrama de carga	18
Load Chart – Main Boom. US STANDARD ASME B30.5 · Tabla de carga	19-20
Technical Specifications · Especificación técnica	
Hydraulic Boom · Pluma hidráulica	21
Hoist · Cabrestante	21
Upper Structure · Superestructura	21
Cab and Controls · Cabina y controles	22
Carrier · Chasis	22
Vehicle Performance · Prestaciones del vehículo.....	23
Tires · Neumáticos	23
Options · Opciones	23
Notes to lifting capacity · Notas sobre la capacidad de elevación	24

LEJENDA

	Counterweight · Contrapeso		Performance · Prestaciones
	Main boom · Pluma principal		Tip height · Altura de la punta
	Boom length · Longitud pluma		Boom elevation angle · Ángulo elevación pluma
	Boom extension · Extensión		Working radius · Radio de trabajo
	Angular offsets · Inclinación		Auxiliary head · Cabeza auxiliar
	Telescoping · Telescopaje		Min. distance between hook block and boom head · Distancia mínima gancho a cabeza pluma
	Outriggers / Lifting on outriggers · Estabilizadores / Elevación sobre estabilizadores		Crane / Crane in standard configuration · Grúa / Grúa configuración estándar
	Slewing brake · Freno de giro		Removable counterweight system · Sistema de contrapeso desmontable
	Slewing / Allowable range · Giro / Rango admisible		Lifting on wheels / Pick & Carry · Elevación sobre ruedas / pick & carry
	Slewing locked · Giro bloqueado		Gross vehicle weight · Peso bruto vehículo
	Slewing gears · Sistema de giro		Weight on front axle · Peso eje delantero
	Hoist speed · Velocidad cabrestante		Weight on rear axle · Peso eje trasero
	Rope · Cable		Hook block · Gancho
	Rope diameter · Diámetro cable		Electric circuit · Circuito eléctrico
	Rope length · Longitud cable		Operation temperature · Temperatura de servicio
	Line pull · Tracción cable		Speed · Velocidad
	Main hoist · Cabrestante principal		Engine · Motor
	Auxiliary hoist · Cabrestante auxiliar		Mechanical transmission · Transmisión mecánica
	Lights · Luces		Cab · Cabina
	Gradeability · Pendiente máx.		Operator aid · Sist. de ayuda al operador
	Heating / Air conditioning · Calefacción / Climatización		Rated weight on hook block · Carga nominal en gancho
	Hydraulics · Sistema hidráulico		No. of sheaves · N° poleas
	Steering · Dirección		Single hook · Gancho simple
	Tires · Neumáticos		Rams-horn hook · Aparejo gancho doble
	Controls · Controles		No. of lines · N° ramales
	Lubrication system · Sistema de lubricación		Differential lock · Bloqueo diferencial

HIGHLIGHTS

CARACTERÍSTICAS DESTACADAS

TRT 100US

- ▶ Rated capacity · Capacidad nominal:
100 USt at 8 ft working radius
100 USt a 8 ft radio de trabajo
- ▶ Maximum main boom length · Longitud de pluma máx.:
154.2 ft
- ▶ Maximum tip height with jib · Altura de la punta máx. con plumín:
216.5 ft
- ▶ Maximum hook height with jib · Altura de gancho máx. con plumín:
209.9 ft

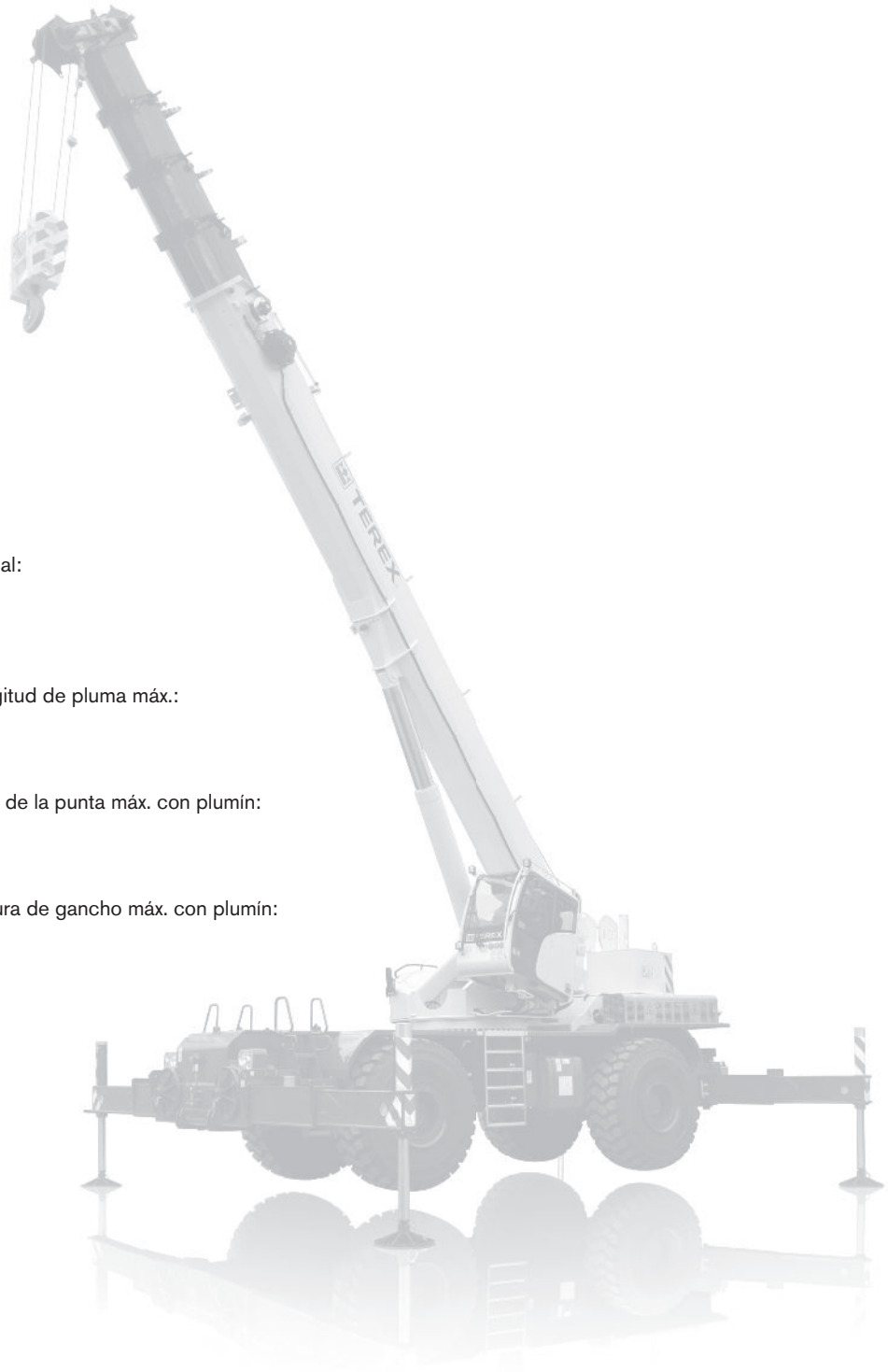

WEIGHTS

PESOS

TRT 100US

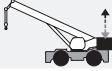
			
 without hook block; tires 26.5R25 sin gancho; neumáticos 26.5R25	115,919 lb	57,421 lb	58,498 lb
 without counterweight · sin contrapeso	93,873 lb	63,368 lb	30,505 lb
Add / Subtract for main optional equipment · Sumar / restar para equipamiento opcional principal			
 Removable counterweight system · Sistema de contrapeso desmontable	+ 331 lb	- 89 lb	+ 420 lb
 29.5-25	+ 1,146 lb	+ 573 lb	+ 573 lb
 55.8 ft jib stowed · Plumin replegado	+ 3,086 lb	+ 5,959 lb	- 2,872 lb
 Auxiliary sheave · Polea auxiliar	+ 176 lb	+ 503 lb	- 327 lb
 2 Auxiliary winch · Cabrestante auxiliar	+ 2,425 lb	- 451 lb	+ 2,876 lb
 6 100 USt hook block, 6 sheaves · Bloque de gancho, 6 poleas	+ 2,094 lb	+ 3,945 lb	- 1,851 lb
 3 55 USt hook block, 3 sheaves · Bloque de gancho, 3 poleas	+ 1,102 lb	+ 2,076 lb	- 974 lb
 1 22 USt hook block, 1 sheave · Bloque de gancho, 1 polea	+ 661 lb	+ 1,246 lb	- 584 lb
 11 USt headache ball · Bola de grúa	+ 397 lb	+ 748 lb	- 351 lb

NOTE: Values are subject to 2% variation · NOTA: Valores sujetos a una variación del 2%

DIMENSIONS

DIMENSIONES

TRT 100US

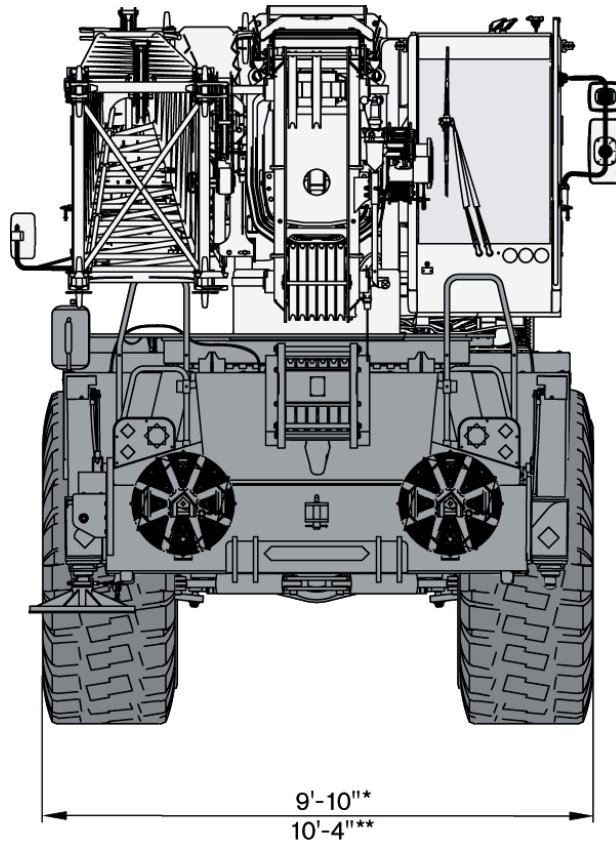

⊙ * 26.5R25
** 29.5-25

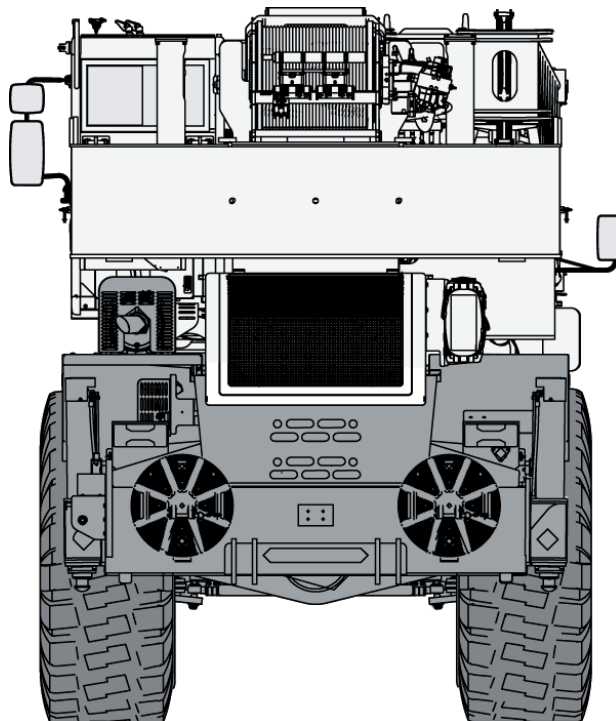

DIMENSIONS

TRT 100US

DIMENSIONES

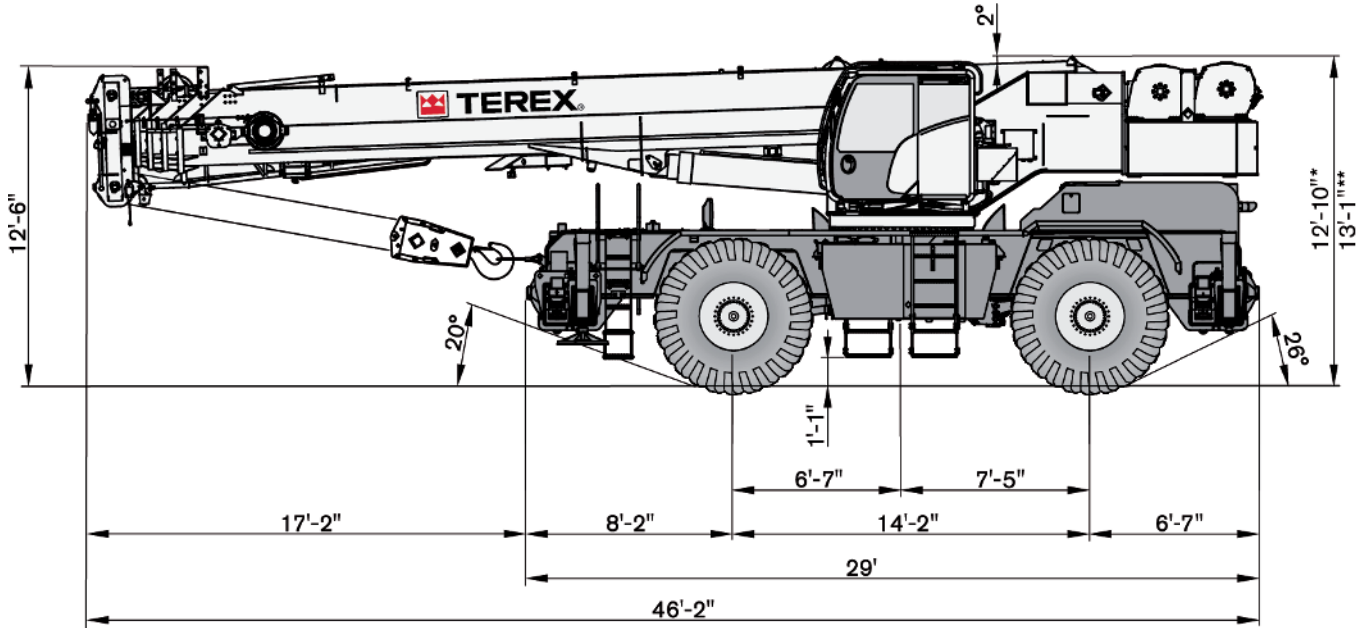

* 26.5R25
** 29.5-25

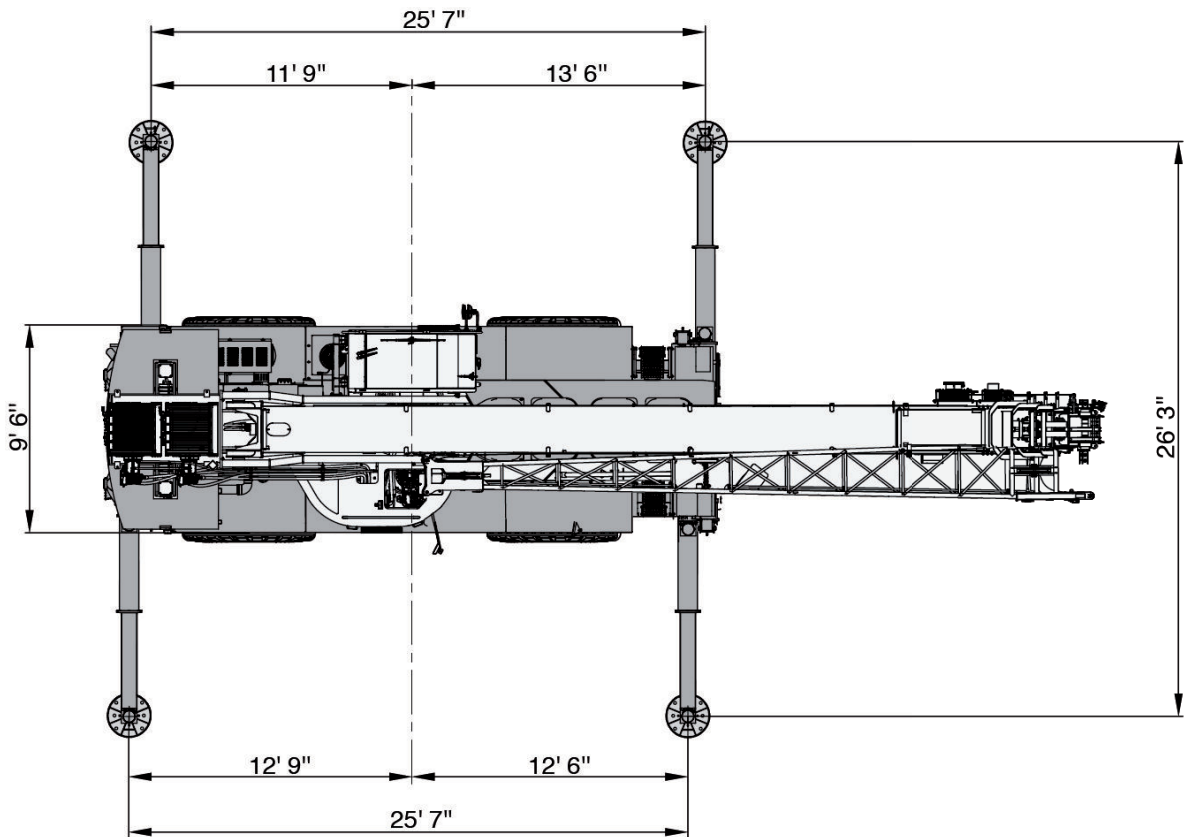

Drawings show optional rooster sheave · Las imágenes muestran polea abatible opcional

STEERING RADII

RADIOS DE DIRECCIÓN

TRT 100US

◎ 26.5R25

Two wheel steer · Dirección en dos ruedas

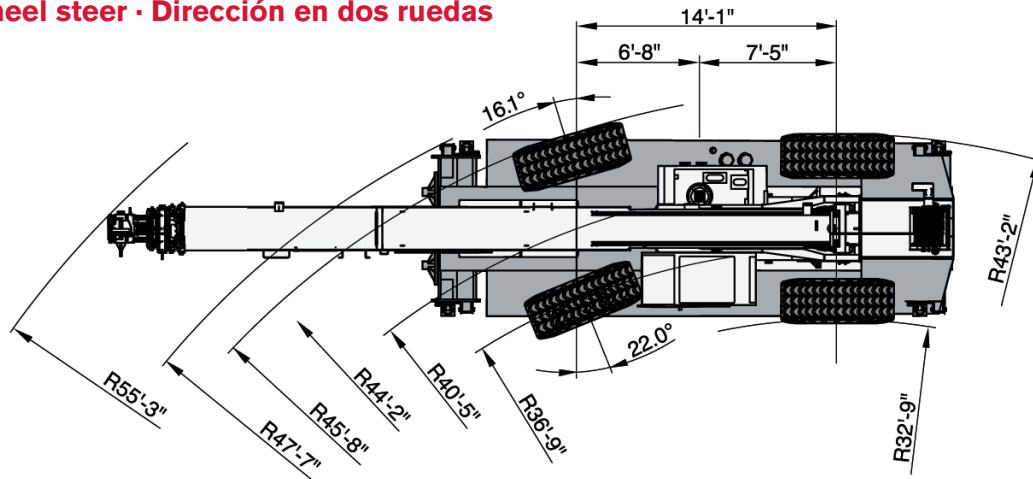

Four wheel steer · Dirección en cuatro ruedas

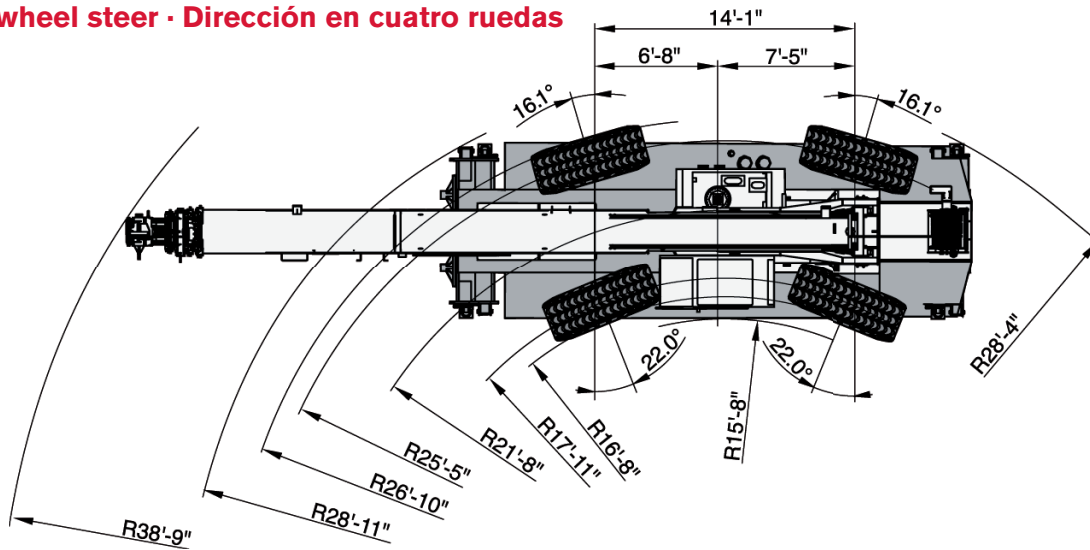

Rear · Atrás

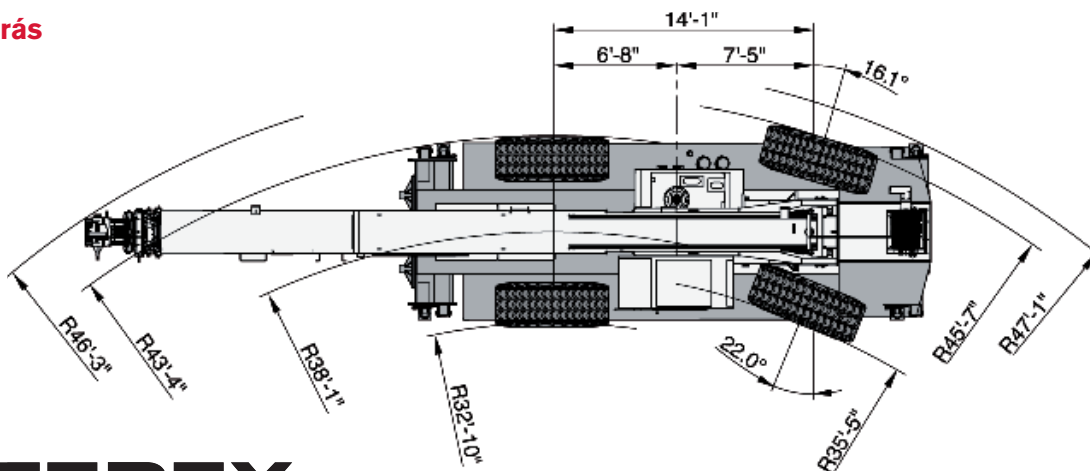

STEERING RADII

RADIOS DE DIRECCIÓN

TRT 100US

29.5-25

Two wheel steer · Dirección en dos ruedas

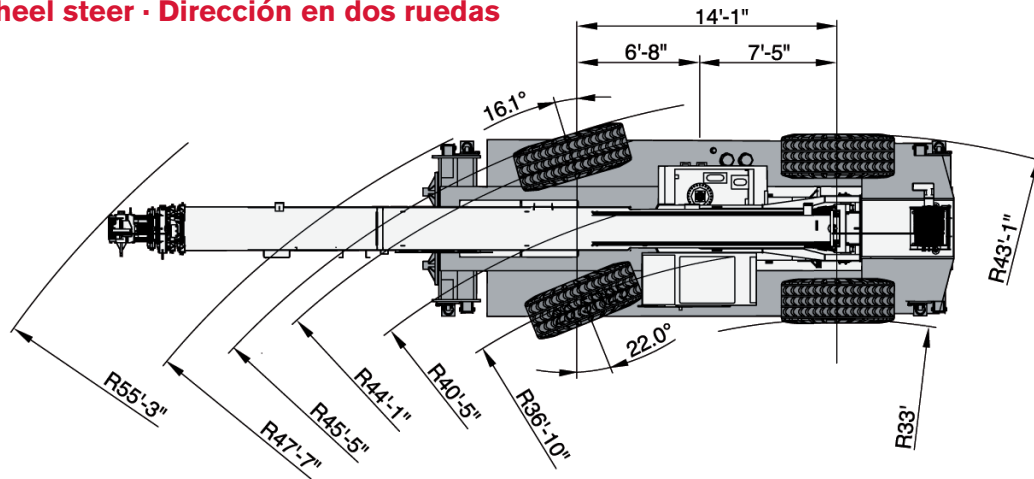

Four wheel steer · Dirección en cuatro ruedas

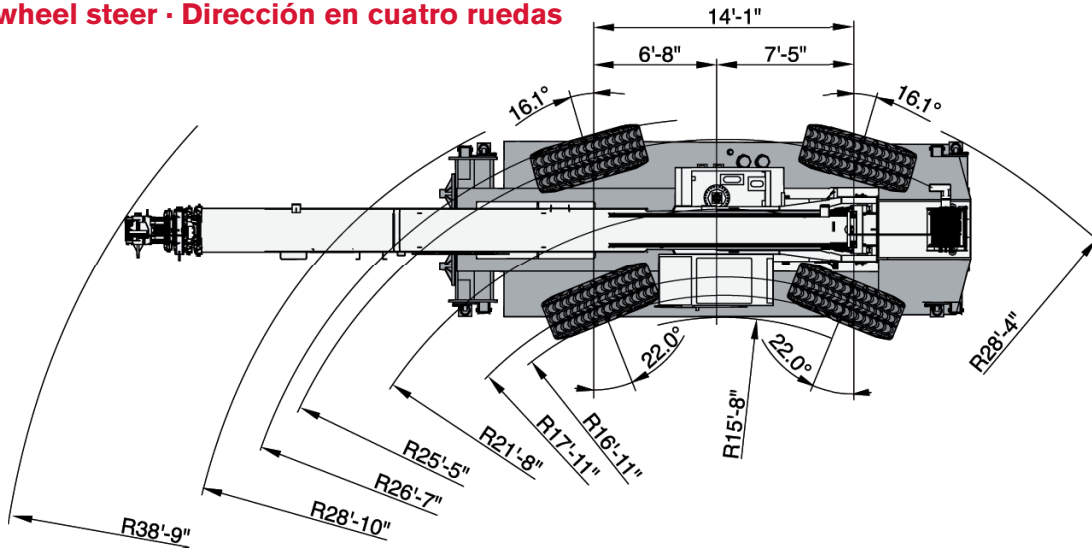

Rear · Atrás

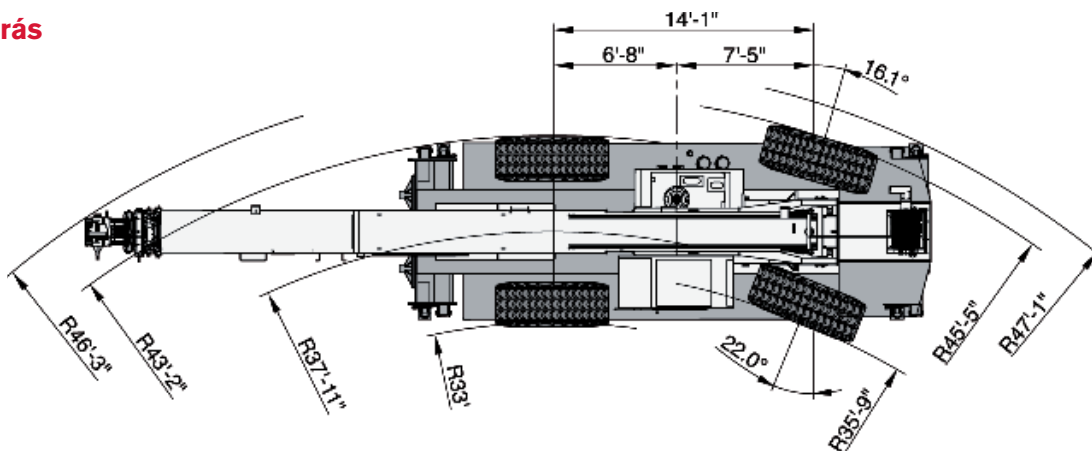

RANGE GRAPH – MAIN BOOM

TRT 100US

DIAGRAMA DE CARGA

Outriggers - Estabilizadores 100 %
3 Modes

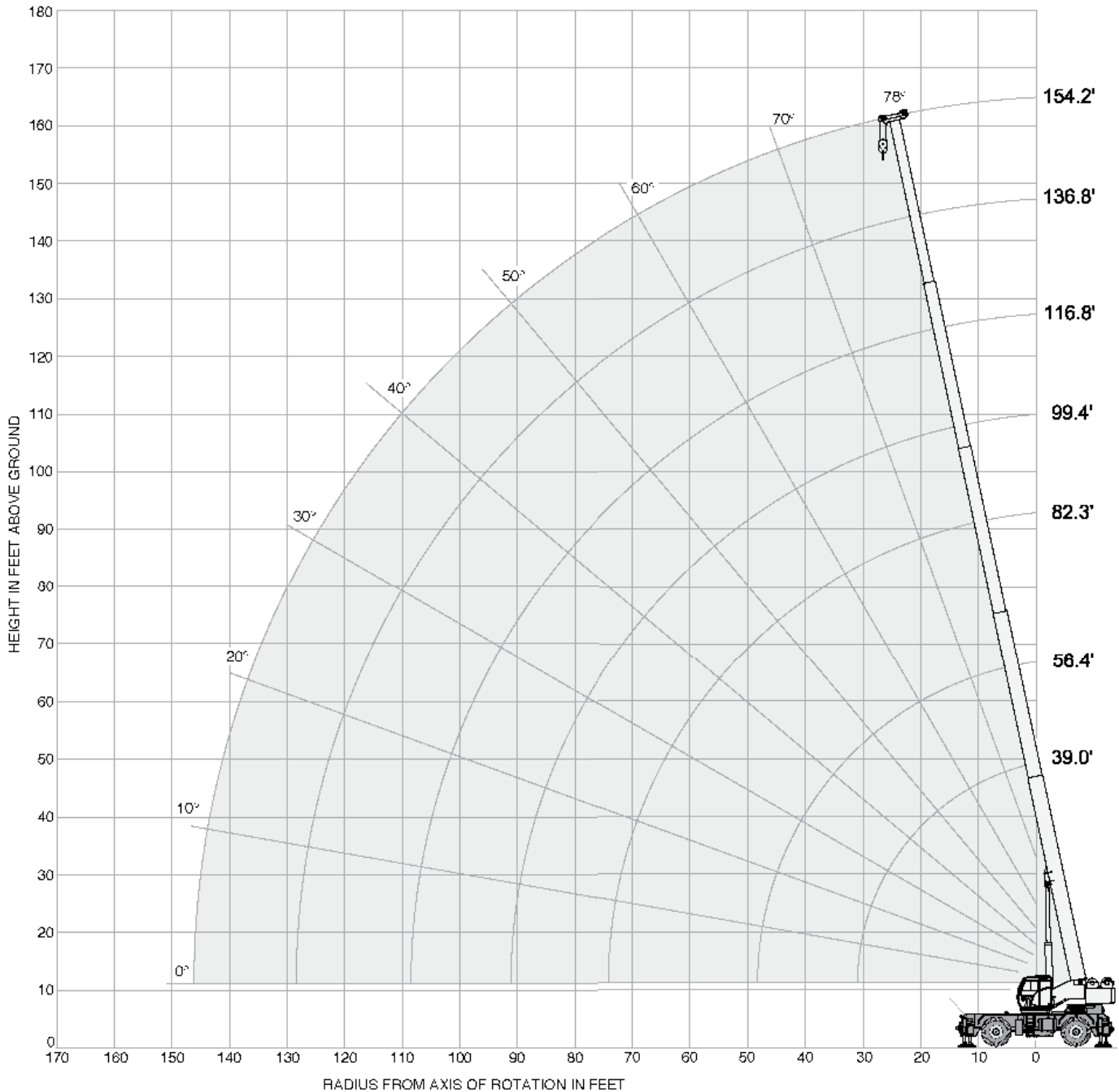
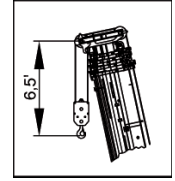

LOAD CHART – MAIN BOOM US STANDARD ASME B30.5

TRT 100US

TABLA DE CARGA

Outriggers · Estabilizadores 100 %

Mode 1:

Stability · Estabilidad



		22,000 lbs		25.6 x 26.2 ft		360°		US STANDARD ASME B30.5							
		39.0 ft	47.9 ft	56.4 ft	64.9 ft	73.5 ft	82.3 ft	90.9 ft	99.4 ft	108.2 ft	116.8 ft	125.3 ft	136.8 ft	154.2 ft	
ft	kip	kip	kip	kip	kip	kip	kip	kip	kip	kip	kip	kip	kip	kip	ft
8.2	191.8	-	-	-	-	-	-	-	-	-	-	-	-	-	8.2
9.8	176.4	81.1	80.0	78.0	-	-	-	-	-	-	-	-	-	-	9.8
11.5	161.4	81.1	80.0	78.0	-	-	-	-	-	-	-	-	-	-	11.5
13.1	148.6	81.1	80.0	78.0	78.7	-	-	-	-	-	-	-	-	-	13.1
14.8	137.6	81.1	80.0	78.0	78.7	-	-	-	-	-	-	-	-	-	14.8
16.4	125.4	81.1	80.0	78.0	78.7	68.3	-	-	-	-	-	-	-	-	16.4
19.7	100.8	81.1	80.0	78.0	78.7	63.3	54.7	-	-	-	-	-	-	-	19.7
23.0	83.8	81.1	80.0	78.0	78.7	58.9	49.6	45.2	37.0	-	-	-	-	-	23.0
26.2	71.2	72.3	72.8	73.2	73.4	55.1	45.2	41.4	36.4	30.0	-	-	-	-	26.2
29.5	61.7	62.6	63.1	63.5	63.7	51.6	41.4	38.1	33.7	30.0	26.9	-	-	-	29.5
32.8	-	55.1	55.6	56.0	56.2	48.7	38.4	35.3	31.3	28.4	25.4	21.2	-	-	32.8
39.4	-	-	41.0	41.4	41.9	42.3	33.3	30.4	26.9	24.5	22.5	21.2	19.6	-	39.4
45.9	-	-	31.1	31.5	32.0	32.2	28.9	26.7	23.4	21.6	19.6	20.3	19.4	19.6	45.9
52.5	-	-	-	24.7	25.1	25.4	25.6	23.4	20.5	19.0	17.2	18.1	16.3	-	52.5
59.0	-	-	-	-	20.3	20.5	20.7	20.9	18.1	16.5	15.0	16.1	13.9	-	59.0
65.6	-	-	-	-	-	17.0	17.2	17.4	15.9	14.3	13.2	14.3	11.9	-	65.6
72.2	-	-	-	-	-	14.1	14.1	14.3	14.3	12.8	11.7	12.8	10.1	-	72.2
78.7	-	-	-	-	-	-	11.9	11.9	12.1	11.7	10.1	11.2	8.8	-	78.7
85.3	-	-	-	-	-	-	-	9.9	10.1	10.1	9.0	9.3	7.5	-	85.3
91.8	-	-	-	-	-	-	-	-	8.4	8.6	7.9	7.7	6.4	-	91.8
98.4	-	-	-	-	-	-	-	-	7.1	7.3	7.1	6.2	4.9	-	98.4
105.0	-	-	-	-	-	-	-	-	-	6.0	6.2	5.1	3.7	-	105.0
111.5	-	-	-	-	-	-	-	-	-	-	5.1	4.0	2.6	-	111.5
118.1	-	-	-	-	-	-	-	-	-	-	-	3.1	1.8	-	118.1
124.6	-	-	-	-	-	-	-	-	-	-	-	2.2	-	-	124.6

LOAD CHART – MAIN BOOM US STANDARD ASME B30.5

TRT 100US

TABLA DE CARGA

Outriggers - Estabilizadores 50 %

**Mode 1:
Stability - Estabilidad**



		22,000 lbs		25.6 x 17.4 ft		360°		US STANDARD ASME B30.5						
	39.0 ft	47.9 ft	56.4 ft	64.9 ft	73.5 ft	82.3 ft	90.9 ft	99.4 ft	108.2 ft	116.8 ft	125.3 ft	136.8 ft	154.2 ft	
ft	kip	kip	kip	kip	kip	kip	kip	kip	kip	kip	kip	kip	kip	ft
8.2	175.7	-	-	-	-	-	-	-	-	-	-	-	-	8.2
9.8	157.4	81.1	80.0	78.0	-	-	-	-	-	-	-	-	-	9.8
11.5	142.6	81.1	80.0	78.0	-	-	-	-	-	-	-	-	-	11.5
13.1	130.1	81.1	80.0	78.0	78.7	-	-	-	-	-	-	-	-	13.1
14.8	115.3	81.1	80.0	78.0	78.7	-	-	-	-	-	-	-	-	14.8
16.4	97.4	81.1	80.0	78.0	78.3	68.3	-	-	-	-	-	-	-	16.4
19.7	67.2	69.0	67.0	64.4	61.7	59.3	54.7	-	-	-	-	-	-	19.7
23.0	49.8	51.1	52.0	52.2	50.5	48.7	47.2	45.2	37.0	-	-	-	-	23.0
26.2	38.8	40.1	40.8	41.2	41.7	41.0	39.7	38.6	36.4	30.0	-	-	-	26.2
29.5	31.3	32.4	33.1	33.5	34.0	34.2	34.2	33.3	32.4	30.0	26.9	-	-	29.5
32.8	-	26.9	27.6	28.0	28.2	28.4	28.9	28.9	28.2	27.6	25.4	21.2	-	32.8
39.4	-	-	19.8	20.3	20.5	20.7	20.9	21.2	21.4	21.6	21.2	19.2	17.0	39.4
45.9	-	-	15.0	15.4	15.7	15.9	16.1	16.3	16.3	16.5	16.5	15.2	13.2	45.9
52.5	-	-	-	11.9	12.1	12.3	12.6	12.8	12.8	13.0	13.0	12.1	10.1	52.5
59.0	-	-	-	-	9.7	9.7	9.9	10.1	10.1	10.4	10.6	9.7	7.9	59.0
65.6	-	-	-	-	-	7.7	7.9	8.2	8.2	8.4	8.4	7.7	6.2	65.6
72.2	-	-	-	-	-	6.4	6.4	6.6	6.6	6.8	6.8	6.2	4.6	72.2
78.7	-	-	-	-	-	-	5.3	5.3	5.3	5.5	5.5	4.9	3.3	78.7
85.3	-	-	-	-	-	-	-	4.2	4.4	4.4	4.4	3.5	2.2	85.3
91.8	-	-	-	-	-	-	-	-	3.3	3.5	3.5	2.6	-	91.8
98.4	-	-	-	-	-	-	-	-	2.4	2.4	2.6	1.8	-	98.4
105.0	-	-	-	-	-	-	-	-	-	1.8	1.8	-	-	105.0

Outriggers - Estabilizadores 0 %

		22,000 lbs		25.6 x 8.9 ft		360°		US STANDARD ASME B30.5						
	39.0 ft	47.9 ft	56.4 ft	64.9 ft	73.5 ft	82.3 ft	90.9 ft	99.4 ft	108.2 ft	116.8 ft	125.3 ft	136.8 ft	148.6 ft	
ft	kip	kip	kip	kip	kip	kip	kip	kip	kip	kip	kip	kip	kip	ft
8.2	94.1	-	-	-	-	-	-	-	-	-	-	-	-	8.2
9.8	75.6	70.3	65.9	61.9	-	-	-	-	-	-	-	-	-	9.8
11.5	62.4	58.9	55.8	52.9	-	-	-	-	-	-	-	-	-	11.5
13.1	51.8	50.3	47.8	45.6	43.7	-	-	-	-	-	-	-	-	13.1
14.8	42.3	43.4	41.7	40.1	38.4	-	-	-	-	-	-	-	-	14.8
16.4	35.3	36.6	36.6	35.5	34.2	32.8	-	-	-	-	-	-	-	16.4
19.7	25.8	26.9	27.6	28.0	27.3	26.5	25.6	-	-	-	-	-	-	19.7
23.0	19.8	20.7	21.4	21.8	22.0	21.8	21.2	20.5	20.1	-	-	-	-	23.0
26.2	15.7	16.5	17.0	17.4	17.6	17.9	17.6	17.2	16.8	16.3	-	-	-	26.2
29.5	12.6	13.2	13.9	14.1	14.6	14.6	15.0	14.6	14.3	13.9	13.7	-	-	29.5
32.8	-	10.8	11.2	11.7	11.9	12.1	12.3	12.3	12.1	11.9	11.7	9.9	-	32.8
39.4	-	-	7.7	8.2	8.4	8.6	8.8	8.8	8.8	8.6	8.4	7.1	5.7	39.4
45.9	-	-	5.5	5.7	6.0	6.2	6.2	6.4	6.4	6.2	6.2	4.9	3.7	45.9
52.5	-	-	-	4.0	4.2	4.2	4.4	4.6	4.4	4.4	4.4	3.1	2.0	52.5
59.0	-	-	-	-	2.6	2.9	3.1	3.1	3.1	2.9	2.9	1.8	-	59.0
65.6	-	-	-	-	-	1.5	1.8	1.8	1.8	1.8	1.8	-	-	65.6

LOAD CHART – MAIN BOOM US STANDARD ASME B30.5

TRT 100US

TABLA DE CARGA

Outriggers · Estabilizadores 100 %

Mode 2:

Strength · Fuerza



		22,000 lbs		25.6 x 26.2 ft		360°		US STANDARD ASME B30.5						
ft	kip	50.5 ft	62.0 ft	72.2 ft	80.7 ft	89.5 ft	98.1 ft	106.6 ft	115.5 ft	124.0 ft	132.5 ft	141.4 ft	154.2 ft	ft
8.2	191.8	-	-	-	-	-	-	-	-	-	-	-	-	8.2
9.8	176.4	167.3	102.3	-	-	-	-	-	-	-	-	-	-	9.8
11.5	161.4	154.5	93.9	-	-	-	-	-	-	-	-	-	-	11.5
13.1	148.6	143.7	86.2	76.3	-	-	-	-	-	-	-	-	-	13.1
14.8	137.6	134.5	80.0	71.0	68.6	-	-	-	-	-	-	-	-	14.8
16.4	125.4	123.5	74.1	66.6	63.7	-	-	-	-	-	-	-	-	16.4
19.7	100.8	99.0	65.5	57.5	55.6	53.8	-	-	-	-	-	-	-	19.7
23.0	83.8	81.8	57.8	50.7	48.9	47.4	45.6	43.7	-	-	-	-	-	23.0
26.2	71.2	69.4	52.0	45.2	43.7	42.3	40.6	38.8	37.7	-	-	-	-	26.2
29.5	61.7	60.0	46.7	40.8	39.0	37.9	36.6	35.1	34.0	32.2	-	-	-	29.5
32.8	-	52.2	42.5	36.6	35.5	34.2	33.3	31.5	30.6	29.8	25.8	-	-	32.8
39.4	-	36.4	35.1	30.2	29.3	28.7	27.6	26.2	25.4	24.7	24.3	23.8	19.6	39.4
45.9	-	-	25.6	25.4	24.7	24.3	23.4	22.3	21.4	20.5	20.1	19.8	19.4	45.9
52.5	-	-	19.2	19.2	20.1	20.7	19.8	19.0	18.1	17.4	17.2	16.8	16.3	52.5
59.0	-	-	-	14.3	15.2	16.1	16.8	16.1	15.7	15.0	14.6	14.3	13.9	59.0
65.6	-	-	-	-	11.7	12.3	13.0	13.4	13.4	12.8	12.6	12.3	11.9	65.6
72.2	-	-	-	-	8.8	9.5	10.1	10.6	11.0	11.0	10.8	10.6	10.1	72.2
78.7	-	-	-	-	-	7.3	7.7	8.2	8.6	9.0	9.3	9.0	8.8	78.7
85.3	-	-	-	-	-	-	6.0	6.4	6.6	7.1	7.5	7.7	7.5	85.3
91.8	-	-	-	-	-	-	-	4.9	5.1	5.5	5.7	6.0	6.4	91.8
98.4	-	-	-	-	-	-	-	3.5	3.7	4.2	4.4	4.6	4.9	98.4
105.0	-	-	-	-	-	-	-	-	2.6	2.9	3.3	3.5	3.7	105.0
111.5	-	-	-	-	-	-	-	-	-	2.0	2.2	2.4	2.6	111.5
118.1	-	-	-	-	-	-	-	-	-	-	-	-	1.8	118.1

LOAD CHART – MAIN BOOM US STANDARD ASME B30.5

TRT 100US

TABLA DE CARGA

Outriggers - Estabilizadores 50 %

**Mode 2:
Strength - Fuerza**



		22,000 lbs		25.6 x 17.4 ft		360°		US STANDARD ASME B30.5							
		39.0 ft	50.5 ft	62.0 ft	72.2 ft	80.7 ft	89.5 ft	98.1 ft	106.6 ft	115.5 ft	124.0 ft	132.5 ft	141.4 ft	154.2 ft	
ft	kip	kip	kip	kip	kip	kip	kip	kip	kip	kip	kip	kip	kip	kip	ft
8.2	175.7	-	-	-	-	-	-	-	-	-	-	-	-	-	8.2
9.8	157.4	156.1	102.3	-	-	-	-	-	-	-	-	-	-	-	9.8
11.5	142.6	141.1	93.9	-	-	-	-	-	-	-	-	-	-	-	11.5
13.1	130.1	119.5	86.2	76.3	-	-	-	-	-	-	-	-	-	-	13.1
14.8	115.3	99.4	80.0	71.0	68.6	-	-	-	-	-	-	-	-	-	14.8
16.4	97.4	84.7	74.1	66.6	63.7	-	-	-	-	-	-	-	-	-	16.4
19.7	67.2	64.2	57.5	54.0	52.5	50.9	-	-	-	-	-	-	-	-	19.7
23.0	49.8	47.4	45.6	43.0	42.3	41.4	40.3	39.5	-	-	-	-	-	-	23.0
26.2	38.8	36.6	35.5	35.1	34.8	34.2	33.7	33.1	32.4	-	-	-	-	-	26.2
29.5	31.3	29.3	28.2	28.4	29.1	28.7	28.4	28.0	27.6	27.1	-	-	-	-	29.5
32.8	-	24.0	22.9	23.1	23.8	24.5	24.3	24.0	23.6	23.4	22.9	-	-	-	32.8
39.4	-	16.8	15.7	15.9	16.5	17.2	17.6	17.9	17.9	17.6	17.4	17.2	17.0	-	39.4
45.9	-	-	11.0	11.2	11.9	12.3	12.8	13.4	13.4	13.4	13.4	13.2	13.2	-	45.9
52.5	-	-	7.9	7.9	8.6	9.0	9.5	9.9	10.4	10.4	10.4	10.4	10.1	-	52.5
59.0	-	-	-	5.3	6.2	6.6	7.1	7.5	7.7	7.9	7.9	7.9	7.9	-	59.0
65.6	-	-	-	-	4.0	4.4	5.1	5.5	5.7	6.0	6.0	6.0	6.0	-	65.6
72.2	-	-	-	-	2.2	2.6	3.3	3.7	4.0	4.2	4.4	4.4	4.4	-	72.2
78.7	-	-	-	-	-	-	1.8	2.2	2.6	2.9	3.1	3.1	3.1	-	78.7
85.3	-	-	-	-	-	-	-	-	-	1.8	1.8	2.0	2.2	-	85.3

Outriggers - Estabilizadores 0 %

		22,000 lbs		25.6 x 8.9 ft		360°		US STANDARD ASME B30.5						
		39.0 ft	50.5 ft	62.0 ft	72.2 ft	80.7 ft	89.5 ft	98.1 ft	106.6 ft	115.5 ft	124.0 ft	132.5 ft	145.6 ft	
ft	kip	kip	kip	kip	kip	kip	kip	kip	kip	kip	kip	kip	kip	ft
8.2	94.1	-	-	-	-	-	-	-	-	-	-	-	-	8.2
9.8	75.6	64.2	55.6	-	-	-	-	-	-	-	-	-	-	9.8
11.5	62.4	53.4	46.5	-	-	-	-	-	-	-	-	-	-	11.5
13.1	51.8	45.2	39.5	36.6	-	-	-	-	-	-	-	-	-	13.1
14.8	42.3	38.8	34.0	31.5	30.9	-	-	-	-	-	-	-	-	14.8
16.4	35.3	33.3	29.3	27.3	26.9	-	-	-	-	-	-	-	-	16.4
19.7	25.8	24.0	22.5	20.9	20.9	20.5	-	-	-	-	-	-	-	19.7
23.0	19.8	18.1	17.2	16.1	16.3	16.3	16.1	15.9	-	-	-	-	-	23.0
26.2	15.7	13.9	13.0	12.6	12.8	13.0	13.0	12.8	12.8	-	-	-	-	26.2
29.5	12.6	10.8	10.1	9.7	9.9	10.1	10.4	10.4	10.4	10.1	-	-	-	29.5
32.8	-	8.6	7.7	7.3	7.7	7.9	8.2	8.4	8.4	8.4	8.2	-	-	32.8
39.4	-	5.3	4.0	3.7	4.2	4.6	4.9	5.1	5.3	5.3	5.3	5.3	5.3	39.4
45.9	-	-	-	-	1.8	2.2	2.4	2.6	2.9	3.1	3.1	3.1	3.1	45.9

LOAD CHART – MAIN BOOM US STANDARD ASME B30.5

TRT 100US

TABLA DE CARGA

Outriggers · Estabilizadores 100 %

Mode 3:

Proportional · Proporcional



		22,000 lbs		25.6 x 26.2 ft		360°		US STANDARD ASME B30.5				
ft	kip	50.5 ft	62.0 ft	73.5 ft	85.3 ft	96.8 ft	108.2 ft	119.7 ft	131.2 ft	142.7 ft	154.2 ft	ft
8.2	191.8	-	-	-	-	-	-	-	-	-	-	8.2
9.8	176.4	80.5	77.8	-	-	-	-	-	-	-	-	9.8
11.5	161.4	80.5	77.8	-	-	-	-	-	-	-	-	11.5
13.1	148.6	80.5	77.8	76.1	-	-	-	-	-	-	-	13.1
14.8	137.6	80.5	77.8	76.1	-	-	-	-	-	-	-	14.8
16.4	125.4	80.5	77.8	76.1	76.5	-	-	-	-	-	-	16.4
19.7	100.8	80.5	77.8	76.1	76.5	61.1	-	-	-	-	-	19.7
23.0	83.8	80.5	77.8	76.1	76.5	58.2	43.0	-	-	-	-	23.0
26.2	71.2	71.6	71.9	72.1	69.4	55.8	43.0	33.1	-	-	-	26.2
29.5	61.7	62.2	62.4	62.4	62.6	52.7	41.0	33.1	-	-	-	29.5
32.8	-	54.7	54.7	54.9	53.8	50.3	37.7	33.1	28.7	-	-	32.8
39.4	-	39.5	39.9	39.9	40.1	39.5	32.4	29.3	24.9	22.5	19.6	39.4
45.9	-	-	30.0	30.0	30.2	30.4	28.2	25.4	20.9	20.1	19.4	45.9
52.5	-	-	23.4	23.4	23.6	23.6	23.8	22.0	17.9	17.0	16.3	52.5
59.0	-	-	-	18.7	18.7	19.0	19.0	19.2	15.4	14.6	13.9	59.0
65.6	-	-	-	-	15.0	15.2	15.2	15.4	13.4	12.6	11.9	65.6
72.2	-	-	-	-	12.1	12.1	12.1	12.3	11.7	10.8	10.1	72.2
78.7	-	-	-	-	-	9.7	9.9	9.9	9.9	9.3	8.8	78.7
85.3	-	-	-	-	-	7.9	7.9	7.9	7.9	7.9	7.5	85.3
91.8	-	-	-	-	-	-	6.2	6.4	6.4	6.4	6.4	91.8
98.4	-	-	-	-	-	-	4.9	5.1	4.9	4.9	4.9	98.4
105.0	-	-	-	-	-	-	-	3.7	3.7	3.7	3.7	105.0
111.5	-	-	-	-	-	-	-	2.9	2.6	2.6	2.6	111.5
118.1	-	-	-	-	-	-	-	-	2.0	1.8	1.8	118.1

LOAD CHART – MAIN BOOM US STANDARD ASME B30.5

TRT 100US

TABLA DE CARGA

Outriggers · Estabilizadores 50 %

Mode 3:

Proportional · Proporcional



		22,000 lbs		25.6 x 17.4 ft		360°		US STANDARD ASME B30.5				
	39.0 ft	50.5 ft	62.0 ft	73.5 ft	85.3 ft	96.8 ft	108.2 ft	119.7 ft	131.2 ft	142.7 ft	154.2 ft	
ft	kip	kip	kip	kip	kip	kip	kip	kip	kip	kip	kip	ft
8.2	175.7	-	-	-	-	-	-	-	-	-	-	8.2
9.8	157.4	80.5	77.8	-	-	-	-	-	-	-	-	9.8
11.5	142.6	80.5	77.8	-	-	-	-	-	-	-	-	11.5
13.1	130.1	80.5	77.8	76.1	-	-	-	-	-	-	-	13.1
14.8	115.3	80.5	77.8	76.1	-	-	-	-	-	-	-	14.8
16.4	97.4	80.5	77.8	75.6	70.1	-	-	-	-	-	-	16.4
19.7	67.2	67.9	63.3	59.3	55.8	52.7	-	-	-	-	-	19.7
23.0	49.8	50.5	50.9	48.3	45.6	43.4	41.2	-	-	-	-	23.0
26.2	38.8	39.5	39.7	39.9	38.1	36.4	34.8	33.1	-	-	-	26.2
29.5	31.3	32.0	32.2	32.4	32.4	31.1	29.8	28.4	-	-	-	29.5
32.8	-	26.5	26.7	26.7	26.9	26.7	25.6	24.7	23.8	-	-	32.8
39.4	-	19.0	19.0	19.2	19.2	19.4	19.4	18.7	18.1	17.4	17.0	39.4
45.9	-	-	14.1	14.3	14.3	14.6	14.6	14.6	14.1	13.7	13.2	45.9
52.5	-	-	10.8	11.0	11.0	11.0	11.2	11.2	11.0	10.6	10.1	52.5
59.0	-	-	-	8.4	8.4	8.6	8.6	8.8	8.6	8.2	7.9	59.0
65.6	-	-	-	-	6.6	6.6	6.6	6.8	6.6	6.4	6.2	65.6
72.2	-	-	-	-	5.1	5.1	5.1	5.1	4.9	4.6	4.6	72.2
78.7	-	-	-	-	-	3.5	3.5	3.7	3.5	3.3	3.3	78.7
85.3	-	-	-	-	-	2.4	2.4	2.4	2.4	2.2	2.2	85.3

Outriggers · Estabilizadores 0 %

		22,000 lbs		24.9 ft x 8.9 ft		360°		US STANDARD ASME B30.5			
	39.0 ft	50.5 ft	62.0 ft	73.5 ft	85.3 ft	96.8 ft	108.2 ft	119.7 ft	131.2 ft	148.6 ft	
ft	kip	kip	kip	kip	kip	kip	kip	kip	kip	kip	ft
8.2	94.1	-	-	-	-	-	-	-	-	-	8.2
9.8	75.6	67.9	61.5	-	-	-	-	-	-	-	9.8
11.5	62.4	56.9	52.0	-	-	-	-	-	-	-	11.5
13.1	51.8	48.5	44.8	41.4	-	-	-	-	-	-	13.1
14.8	42.3	41.9	39.0	36.4	-	-	-	-	-	-	14.8
16.4	35.3	35.9	34.2	32.2	30.0	-	-	-	-	-	16.4
19.7	25.8	26.5	26.7	25.6	24.0	22.7	-	-	-	-	19.7
23.0	19.8	20.3	20.5	20.5	19.4	18.5	17.6	-	-	-	23.0
26.2	15.7	16.1	16.3	16.3	15.9	15.2	14.3	13.7	-	-	26.2
29.5	12.6	12.8	13.0	13.2	13.2	12.6	11.9	11.2	-	-	29.5
32.8	-	10.4	10.6	10.8	10.8	10.4	9.9	9.3	8.8	-	32.8
39.4	-	7.1	7.1	7.3	7.3	7.1	6.6	6.2	6.0	5.5	39.4
45.9	-	-	4.9	4.9	4.6	4.4	4.2	4.0	3.7	3.3	45.9
52.5	-	-	2.9	2.9	2.6	2.4	2.4	2.2	2.0	1.5	52.5

LOAD CHART – MAIN BOOM US STANDARD ASME B30.5

TRT 100US

TABLA DE CARGA

On Tires · Sobre neumáticos

Mode 3:

Proportional · Proporcional



		22,000 lbs		0 mph		US STANDARD ASME B30.5				
		39.0 ft	44.9 ft	50.5 ft	56.4 ft	62.0 ft	67.9 ft	73.5 ft	79.4 ft	
ft	kip									ft
14.8	27.3	25.6	24.0	22.5	21.4	20.1	19.0	17.9	17.9	14.8
16.4	24.0	22.5	21.2	20.1	19.0	17.9	17.0	15.9	15.9	16.4
19.7	19.0	17.9	16.8	15.9	15.0	14.3	13.4	12.8	12.8	19.7
23.0	15.0	14.1	13.4	12.8	12.1	11.5	10.8	10.4	10.4	23.0
26.2	12.1	11.5	10.8	10.1	9.7	9.3	8.6	8.2	8.2	26.2
29.5	9.7	9.3	8.6	8.2	7.7	7.3	6.8	6.4	6.4	29.5
32.8	-	7.5	6.8	6.4	6.2	5.7	5.3	5.1	5.1	32.8
39.4	-	-	4.2	3.7	3.5	3.3	3.1	2.6	2.6	39.4
45.9	-	-	-	2.0	1.8	-	-	-	-	45.9

		22,000 lbs		1.2 mph		US STANDARD ASME B30.5				
		39.0 ft	44.9 ft	50.5 ft	56.4 ft	62.0 ft	67.9 ft	73.5 ft	79.4 ft	
ft	kip									ft
8.2	54.5	-	-	-	-	-	-	-	-	8.2
9.8	48.1	48.5	48.7	48.7	48.9	48.9	-	-	-	9.8
11.5	42.8	43.2	43.4	43.4	43.7	43.7	-	-	-	11.5
13.1	38.4	38.8	39.0	39.0	39.0	39.2	39.2	-	-	13.1
14.8	34.4	35.1	35.3	35.3	35.3	35.5	35.5	35.5	35.5	14.8
16.4	31.1	31.7	32.0	32.0	32.0	32.2	32.2	32.2	32.2	16.4
19.7	25.8	26.5	26.5	26.7	26.7	26.7	26.9	26.9	26.9	19.7
23.0	21.6	22.0	22.3	22.5	22.5	22.5	22.7	22.7	22.7	23.0
26.2	18.3	18.7	19.0	19.0	19.2	19.2	19.2	19.2	19.2	26.2
29.5	15.4	15.9	16.1	16.3	16.3	16.3	16.5	16.5	16.5	29.5
32.8	-	13.7	13.7	13.9	14.1	14.1	14.1	14.1	14.1	32.8
39.4	-	-	10.1	10.1	10.4	10.4	10.4	10.4	10.4	39.4
45.9	-	-	-	7.5	7.5	7.7	7.7	7.7	7.7	45.9
52.5	-	-	-	-	5.3	5.5	5.5	5.5	5.5	52.5

RANGE GRAPH - JIB

DIAGRAMA DE CARGA

TRT 100US

55.8 ft offset - angulamiento

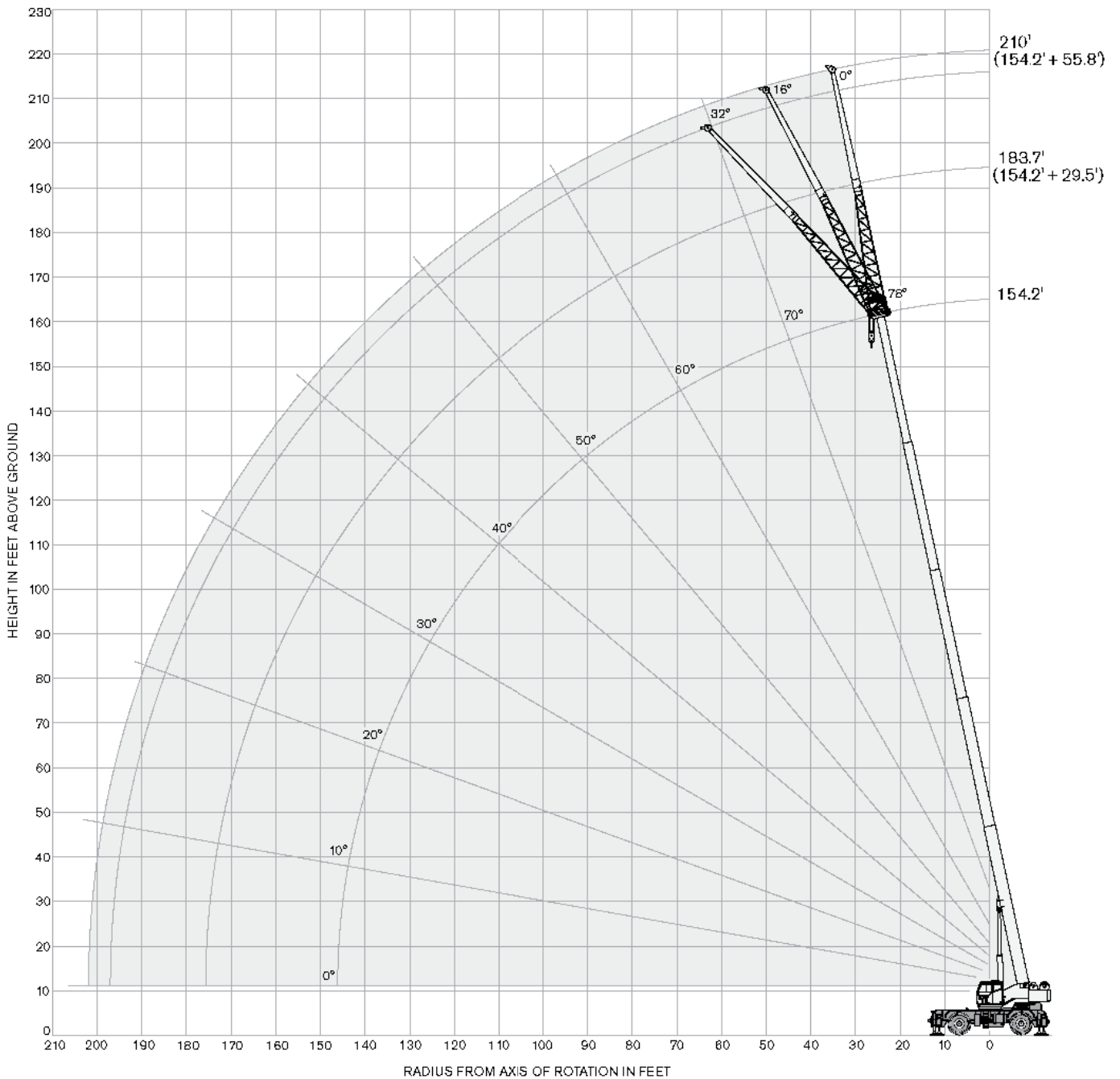
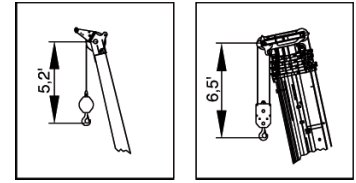

LOAD CHART – JIB US STANDARD ASME B30.5

TRT 100US











TABLA DE CARGA











Outriggers · Estabilizadores 100 %

Mode 3:

Proportional · Proporcional



  22,000 lbs		 25.6 x 26.2 ft		 360°		US STANDARD ASME B30.5				
	 125.3 ft		 29.5 ft		 154.2 ft		 29.5 ft			
	0°	16°	32°	0°	16°	32°	0°	16°		32°
ft	kip	kip	kip	kip	kip	kip	kip	kip	kip	ft
39.4	18.7	-	-	-	-	-	-	-	-	39.4
45.9	18.7	16.3	-	-	-	-	-	-	-	45.9
52.5	18.3	15.7	13.7	-	11.0	-	-	-	-	52.5
59.0	16.8	15.0	13.2	-	11.0	11.0	-	-	-	59.0
65.6	14.8	14.6	13.0	-	11.0	10.4	9.5	-	-	65.6
72.2	12.8	13.7	12.8	-	10.1	9.5	8.8	-	-	72.2
78.7	10.4	11.5	12.3	-	8.8	8.8	8.2	-	-	78.7
85.3	8.4	9.5	10.1	-	7.5	7.9	7.7	-	-	85.3
91.8	6.8	7.5	8.2	-	6.2	7.1	7.1	-	-	91.8
98.4	5.3	6.2	6.6	-	4.9	5.5	6.4	-	-	98.4
105.0	4.2	4.9	5.3	-	3.5	4.4	4.9	-	-	105.0
111.5	3.1	3.7	4.2	-	2.4	3.3	3.7	-	-	111.5
118.1	2.2	2.6	3.1	-	1.5	2.2	2.6	-	-	118.1
124.6	-	1.8	2.0	-	-	-	1.8	-	-	124.6

  22,000 lbs		 25.6 x 26.2 ft		 360°		US STANDARD ASME B30.5				
	 125.3 ft		 55.8 ft		 154.2 ft		 55.8 ft			
	0°	16°	32°	0°	16°	32°	0°	16°		32°
ft	kip	kip	kip	kip	kip	kip	kip	kip	kip	ft
45.9	8.8	-	-	-	-	-	-	-	-	45.9
52.5	8.6	-	-	-	-	-	-	-	-	52.5
59.0	7.9	6.4	-	-	6.8	-	-	-	-	59.0
65.6	7.7	6.2	-	-	6.8	-	-	-	-	65.6
72.2	7.3	5.7	4.9	-	6.8	5.5	-	-	-	72.2
78.7	6.8	5.5	4.6	-	6.6	5.5	-	-	-	78.7
85.3	6.6	5.5	4.6	-	6.4	5.3	4.6	-	-	85.3
91.8	6.2	5.1	4.4	-	6.2	5.3	4.4	-	-	91.8
98.4	6.0	5.1	4.2	-	5.1	5.1	4.4	-	-	98.4
105.0	5.3	4.9	4.2	-	4.0	4.9	4.4	-	-	105.0
111.5	4.2	4.6	4.2	-	3.1	4.4	4.2	-	-	111.5
118.1	3.3	4.2	4.2	-	2.2	3.5	4.2	-	-	118.1
124.6	2.4	3.3	4.0	-	1.5	2.6	3.5	-	-	124.6
131.2	1.8	2.4	3.1	-	-	1.8	2.6	-	-	131.2
137.8	-	1.8	2.2	-	-	-	1.8	-	-	137.8

LOAD CHART – JIB US STANDARD ASME B30.5

TRT 100US











TABLA DE CARGA











Outriggers · Estabilizadores 50 %

Mode 3:

Proportional · Proporcional



  22,000 lbs		 25.6 x 17.4 ft		 360°		US STANDARD ASME B30.5			
 ft	 125.3 ft		 29.5 ft		 154.2 ft		 29.5 ft		 ft
	0°	16°	32°	0°	16°	32°			
	kip	kip	kip	kip	kip	kip	kip		
39.4	17.2	-	-	-	-	-	-	39.4	
45.9	13.4	15.0	-	-	-	-	-	45.9	
52.5	10.6	11.9	13.2	9.0	-	-	-	52.5	
59.0	8.2	9.5	10.6	6.8	8.2	-	-	59.0	
65.6	6.4	7.5	8.4	5.1	6.4	7.3	-	65.6	
72.2	4.9	5.7	6.6	3.7	4.9	5.7	-	72.2	
78.7	3.5	4.4	5.1	2.4	3.5	4.2	-	78.7	
85.3	2.4	3.1	3.7	-	2.4	3.1	-	85.3	
91.8	-	2.2	2.6	-	-	2.0	-	91.8	
98.4	-	-	1.8	-	-	-	-	98.4	





  22,000 lbs		 25.6 x 17.4 ft		 360°		US STANDARD ASME B30.5			
 ft	 125.3 ft		 55.8 ft		 154.2 ft		 55.8 ft		 ft
	0°	16°	32°	0°	16°	32°			
	kip	kip	kip	kip	kip	kip	kip		
45.9	8.8	-	-	-	-	-	-	45.9	
52.5	8.6	-	-	-	-	-	-	52.5	
59.0	7.9	6.4	-	6.8	-	-	-	59.0	
65.6	6.8	6.2	-	5.5	-	-	-	65.6	
72.2	5.5	5.7	4.9	4.2	5.5	-	-	72.2	
78.7	4.2	5.5	4.6	2.9	4.6	-	-	78.7	
85.3	3.1	4.4	4.6	2.0	3.5	4.6	-	85.3	
91.8	2.2	3.5	4.4	-	2.4	3.7	-	91.8	
98.4	-	2.4	3.5	-	1.5	2.6	-	98.4	
105.0	-	1.8	2.6	-	-	1.8	-	105.0	
111.5	-	-	1.8	-	-	-	-	111.5	

TECHNICAL SPECIFICATIONS







TRT 100US

ESPECIFICACIÓN TÉCNICA



Hydraulic Boom · Pluma hidráulica

	5 sections · 5 secciones	
	Triple mode · Modo triple	Mode 1: Optimized for best capacity on longer radius · Optimizado para mejor capacidad con radio más grande Mode 2: Optimized for best capacity on short radius · Optimizado para mejor capacidad con radio más corto Mode 3: Full proportional · Totalmente proporcional
	Min. / Max. · Mín. / Máx.	39 ft / 154.2 ft
	Max. tip height main boom · Altura de la punta máx. pluma principal	164.0 ft
	Boom luffing angle range (min. / max.) · Ángulos de elevación de la pluma (mín. / máx.)	-2° / +78°
	Boom raising / lowering time⁽¹⁾ · Tiempo de elevación / descenso de la pluma ⁽¹⁾	50 s / 55 s
	Boom extension / retraction time⁽¹⁾ · Tiempo de extensión / retracción de la pluma ⁽¹⁾	120 s / 125 s

Hoist · Cabrestante

	Hydraulic motor · Motor hidráulico Rope roller device · Sistema de tensado de cable Normally engaged brake · Freno activado en estado normal	
	2 speeds · 2 velocidades	
	Max.⁽¹⁾ · Máx.⁽¹⁾	502 ft/min. (6th layer · 6° strato)
	Rotational resistant · Antirotación	
		3/4 in
		820 ft
	Permissible line pull · Tracción de cable admisible	16,000 lbs

Upper Structure · Superestructura

		22,000 lbs
	Non stop · Sin fin	360°
	Maximum speed⁽¹⁾ · Velocidad máxima ⁽¹⁾	1.0 rpm
	Hydraulic motor · Motor hidráulico Planetary reducer · Reductor planetario	

TECHNICAL SPECIFICATIONS

TRT 100US

ESPECIFICACIÓN TÉCNICA

Cab and Controls · Cabina y controles



S-space cab · Cabina S-space:

Sliding door · Puerta deslizante

Wide visibility · Amplia visibilidad

Front and upper window with windscreen wiper · Luna frontal y superior con limpiaparabrisas

Upper windows can be opened · Lunas superiores con apertura

Tiltable cab · Cabina abatible

Fully adjustable seat onto shockproof suspensions · Asiento totalmente ajustable con suspensión anti-impacto

Equipped with tiltable arm rests with integrated hand controls for crane operation · Equipado con apoyabrazos abatible con controles integrados para operación de grúa

Radio with CD player · Radio con reproductor de CD

Seat belts · Cinturones de seguridad



Climatized cab · Cabina climatizada

Air-conditioning · Climatización



Electro-proportional joysticks · Joystick electroproporcionados

TEOS – Terex Operating System. Electronic control with 10" touch screen display ·
TEOS – Sistema Operativo Terex. Control electrónico con pantalla táctil de 10"



Adjustable working LED light outside the cab (3 lights) · Luz de trabajo LED ajustable en el exterior de la cabina (3 luces)



T-LINK Telematics · Sistema telemático T-LINK

Carrier · Chasis



Cummins QSB6.7 Stage V – Tier 4f · Cummins QSB6.7 Stage V – Tier 4f

No. of cylinders · Nº cilindros

6

Gross power · Potencia bruta

225 hp @ 2200 rpm

Maximum gross torque · Par de fuerza máx.

875 lb-ft @ 1300 rpm

Fuel tank capacity · Volumen depósito combustible

79 gallons

Diesel Exhaust Fluid (DEF) · Fluido para descarga de diesel (DEF)

10 gallons



Front wheel steering · Dirección en las ruedas delanteras

Rear wheel steering · Dirección en las ruedas traseras

Four wheel steering concentric · Dirección en las cuatro ruedas, concéntrica

Four wheel steering crab · Dirección en las cuatro ruedas, modo cangrejo





Rear axle differential lock · Bloqueo diferencial eje trasero

TECHNICAL SPECIFICATIONS

TRT 100US

ESPECIFICACIÓN TÉCNICA

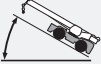





Vehicle Performance · Prestaciones del vehículo

	Max. ⁽²⁾ · Máx. ⁽²⁾		76 %
	Max. ⁽²⁾ · Máx. ⁽²⁾	Tires · Neumáticos 29.5-25 Tires · Neumáticos 26.5R25	19.3 mph 18.0 mph
	Min. / Max. · Min. / Máx.	(-20° C with special fluids and options · -20° C con líquidos especiales y opciones)	
			-20° / 45°C

Tires · Neumáticos

	Earth moving style · Para movimiento de tierra	29.5-25
---	--	---------

Options · Opciones

	Cummins QSB6.7 Stage IIIA – Tier 3 · Cummins QSB6.7 Stage IIIA – Tier 3	
	No. of cylinders · Nº cilindros	6
	Gross power · Potencia bruta	220 hp @ 2200 rpm
	Maximum gross torque · Par de fuerza máx.	700 lb-ft @ 1500 rpm
	Fuel tank capacity · Volumen depósito combustible	79 gallons
	2	Auxiliary winch · Cabrestante auxiliar
		26.5R25
	Bi-fold extension · Extensión de plegado doble	29.5 ft / 55.8 ft
	Rooster sheave · Polea abatible	
	Auxiliary diesel heater · Calefacción diésel auxiliar	
	Centralized lubrication system · Sistema de lubricación centralizado	

Note: refer to your local dealer for a full list of options.

(1) Indicative value only for reference.

(2) Standard crane in travelling configuration – value calculated with nominal tire radius and max power delivered to the wheels.

Nota: consulte la lista completa de opciones en su distribuidor local.

(1) Valor indicativo, sólo de referencia.

(2) Grúa estándar en configuración de marcha – valor calculado considerando el radio nominal del neumático y máxima potencia en las ruedas.

NOTES TO LIFTING CAPACITY

TRT 100US

NOTAS SOBRE LA CAPACIDAD DE ELEVACIÓN

Weight of hook blocks and slings is considered part of the load and must be subtracted from the capacity ratings. Consult operation manual for further details.

Note: Data published herein is intended as a guideline only and shall not be construed to warrant applicability for lifting purposes. For actual crane operation refer to the computer charts and the operating manual, both of which are supplied with the crane.

Los pesos de los ganchos y las eslingas se consideran parte de la carga y tienen que ser restados de las capacidades nominales. Consulte el manual de instrucciones para más detalles.

Nota: Los datos publicados se proporcionan a título informativo, por tanto, no se consideraran vinculantes a los efectos de la garantía de la capacidad de elevación.

Para operar la grúa deben cumplirse las tablas originales y el manual de instrucciones suministrados con la grúa.

A large rectangular area with horizontal lines, intended for taking notes. The lines are evenly spaced and cover the majority of the page's width and height.

A large rectangular area with a light gray background and horizontal white lines, intended for handwritten notes.

A large rectangular area with a light gray background and horizontal white lines, serving as a template for notes. The lines are evenly spaced and extend across the width of the page, providing a guide for writing.

TEREX CRANES

Rough Terrain Cranes

Via Cassoletta, 76 – loc. Crespellano
40053 Valsamoggia (BO)
Italy

Ph: +39 051 6501011
Email: mktg.cranes@terex.com

Tower Cranes

Via delle Innovazioni, 17
33074 Fontanafredda (PN)
Italy

Ph: +39 0434 989111
Email: mktg.cranes@terex.com

August 2021. Product specifications and prices are subject to change without notice or obligation. The photographs and/or drawings in this document are for illustrative purposes only. Refer to the appropriate Operator's Manual for instructions on the proper use of this equipment. Failure to follow the corresponding Operator's Manual when using our equipment or to otherwise act responsibly may result in serious injury or death. The only warranty applicable to our equipment is the standard written warranty applicable to the particular product and sale and Terex makes no other warranty, express or implied. Products and services listed may be trademarks, service marks or trade-names of Terex Corporation and/or its subsidiaries in the USA and other countries. All rights are reserved. Terex, the Terex Crown design and Works For You are trademarks of Terex Corporation or its subsidiaries.

Agosto 2021. Las especificaciones y los precios de los productos están sujetos a cambios sin necesidad de previo aviso ni ninguna otra obligación. Las fotografías y/o dibujos de este documento tienen un fin meramente ilustrativo. Consulte el correspondiente manual de instrucciones del operario para obtener más información sobre el uso correcto de esta maquinaria. No respetar el manual del operario al utilizar la maquinaria o actuar de forma irresponsable puede provocar lesiones graves e incluso mortales. La única garantía aplicable a nuestra maquinaria es la garantía escrita estándar de cada producto y venta. Terex no amplía dicha garantía de forma expresa ni implícita. Los productos y servicios mencionados pueden ser marcas comerciales, marcas de servicio o nombres de marca de Terex Corporation o de alguna de sus filiales en Estados Unidos y otros países. Todos los derechos reservados. Terex, el diseño de la corona Terex y Works For You son marcas registradas de Terex Corporation o de sus filiales.



www.terex.com/cranes

Brochure Reference: RT-DS-I-E/S-TRT100US-08/21



WORKS FOR YOU.™