

# SUMITOMO

## EXCAVATORS

### SH500LHD-7 SH520LHD-7

- Engine Rated Power (Net): 270 kW
- Operating Weight:
  - SH500LHD-7 ..... 50,800 kg
  - SH520LHD-7 ..... 52,100 kg
- Bucket Capacity (ISO Heaped): 2.9~3.1 m<sup>3</sup>

HYDRAULIC EXCAVATOR FOR REAL PERFORMANCE

**LEGEST**

# SUMITOMO

SH500LHD/520LHD-7 Hydraulic Excavator



## SUMITOMO CONSTRUCTION MACHINERY CO., LTD.

731-1 Naganumahara-cho, Inage-ku, Chiba, 263-0001 Japan  
For further information please contact: Phone : +81-43-420-1829 Facsimile : +81-43-420-1907

We are constantly improving our products and therefore reserve the right to change designs and specifications without notice.  
Illustrations may include optional equipment and accessories and may not include all standard equipment.



**EU Stage V**

# Advances Abound. Innovation Infinite.

## Setting a new bar for worksite proficiencies. The All-new LEGEST.

The new LEGEST series from Sumitomo has been developed to exceed its own capabilities in every regard, with performance benchmarks that will stand the test of time and innovation to tackle any job. Created for more seamless operations in an extensive range of worksite surroundings, both businesses and operators will come to treasure the performance the LEGEST is capable of providing. Unleash the potential on your worksite with capabilities never before seen.

**LEGEST**

### Advanced Energy Efficiency and Eco-friendly Operation 04-07

- Clean and Fuel-efficient Engine "SPACE 5 α"
- Innovative Hydraulic System "SIH:S α"
- SUMITOMO Technology for Fuel Efficiency

### Unparalleled Performance 08-09

### Advanced Operator Comfort 10-11

- New Monitor
- New Air Suspension Seat

### Sophisticated Safety Features 12-13

- Rear and Right Side Camera

### Superior Ease-of-maintenance and Durability 14-16

- Layout for Ease-of-maintenance
- EMS

### Specifications 17-23

## Advanced Energy Efficiency and Eco-friendly Operation

The combination of the advanced clean engine "SPACE 5 α" and SUMITOMO's proprietary hydraulic system "SIH:S α" achieves much higher operating efficiency and superior fuel economy. These features also mean the excavator is even easier on the environment and worksites.

## Faster Operations and Excellent Fuel Economy! H Mode for Equivalent or Better Productivity than Previous SP Mode!

Clean engine **SPACE5 α Alpha** × Innovative hydraulic system **SIH:S α Alpha** = **12%\* less fuel consumption**

\* Comparison of fuel consumption with same workload (SH500LHD-7 H mode compared against SH500LHD-6 SP mode)  
The level of reduction may be less than shown above depending on actual job type.

### Meets EU Stage V standards

The clean engine "SPACE 5 α" achieves significant reductions in exhaust gas emissions, meeting European Stage V non-road emission standards (EU Stage V), deemed the toughest emissions standards in the world. The SH500LHD-7 series excavator has been designed to be even more environmentally friendly.

**NOx: 90% reduction**  
**PM: 92% reduction**  
(compared to SH500LHD-6)

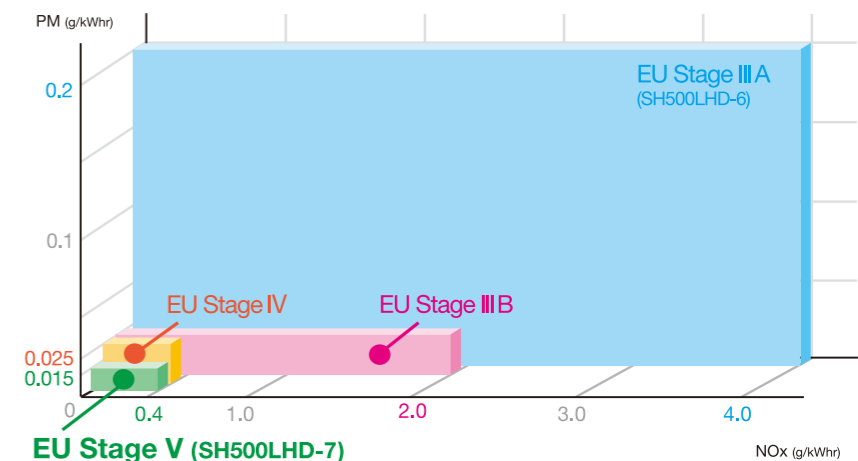

### Clean and Fuel-efficient Engine "SPACE 5 α"

The SH500LHD-7 is powered by a new engine designed for significantly improved combustion efficiency and much lower fuel consumption. In addition to a common rail fuel injection system designed for optimum fuel injection, a cooled EGR and VG turbocharger help to achieve cleaner exhaust gas emissions as well as superior power and response.

### Exhaust After Treatment System (ATS)

An advanced exhaust after treatment system has been used, featuring a combination of a ceramic filter and SCR. The pre-stage ceramic filter removes PM through collection and combustion, while the post-stage SCR injects AdBlue® (urea water) into the exhaust gas, cleaning the NOx into harmless nitrogen and water through chemical reaction. Post treatment of NOx allows for high-efficiency combustion at the engine, achieving superior clean running as well as powerful and low fuel consumption operation.

AdBlue® is a registered trademark of the German Association of the Automotive Industry.

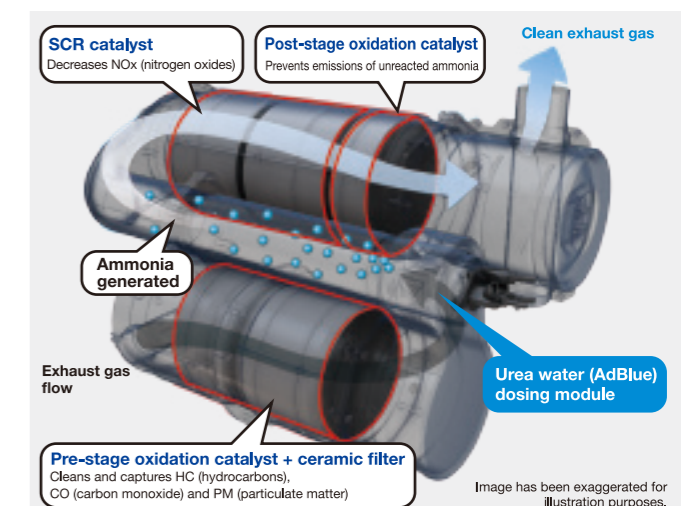

#### SCR System Design

The SCR system comprises an oxidation catalyst, SCR catalyst and urea water dosing module. The urea water is injected into the exhaust gas, where the NOx is reduced by the SCR catalyst and ammonia generated from the urea water and broken down into harmless nitrogen and water, resulting in clean exhaust gases.

SCR: Selective Catalytic Reduction

## Advanced Energy Efficiency and Eco-friendly Operation

### Innovative Hydraulic System "SIH:S α"

An innovative hydraulic system has been used to reduce fuel consumption, while a fully electronically controlled hydraulic pump ensures precision flow control. Further enhancements have also been made to SUMITOMO's proprietary Spool Stroke Control for optimum hydraulic control to suit job conditions, thus achieving even more efficient operations and significantly lower fuel consumption.

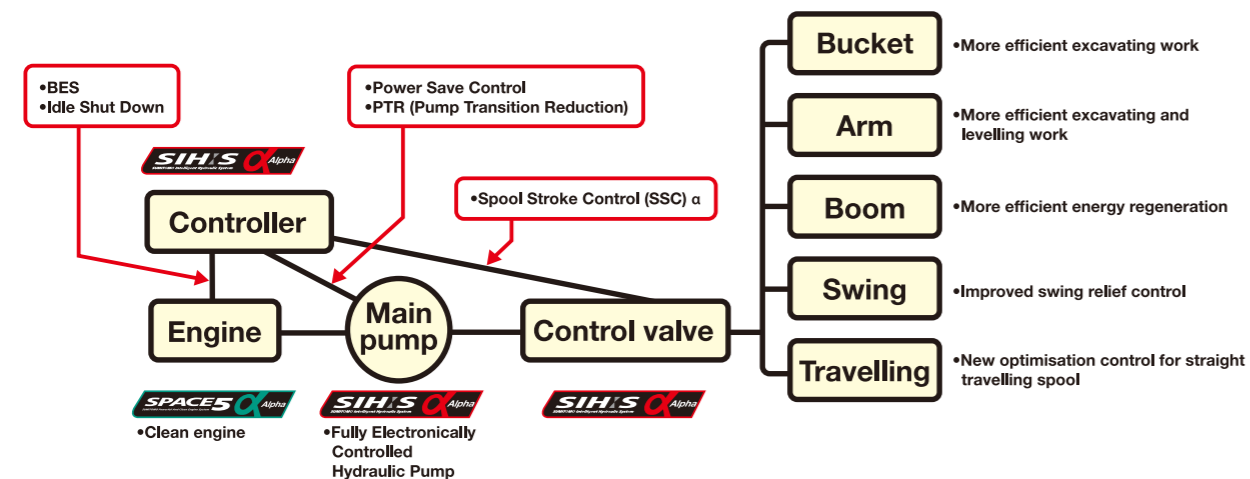

### Three Working Modes for Economic Operation or Work Efficiency



Three working modes are available: SP (Super Power) for faster operations, H (Heavy) for heavy duty applications, and A (Auto) for fuel efficiency across a wide range of operations. Six levels are shown for A mode, making it easier to select the right mode for any jobsite.



#### Integrated Throttle Mode Selector

The throttle mode can be selected by simply turning the knob, so anyone can easily choose the optimum working mode.

### SUMITOMO Technology for Fuel Efficiency

#### •Spool Stroke Control (SSC) α SUMITOMO UNIQUE DESIGN

Automatically adjusts hydraulic pressure to save fuel. Better precision for identifying operating conditions and greater range of control help to reduce fuel consumption and increase operating efficiency even further.

#### •Fully Electronically Controlled Hydraulic Pump SUMITOMO UNIQUE DESIGN

Designed with ultra-sensitive hydraulic pressure sensing technology for precision flow rate control to suit any type of job. These help to achieve speed, enhance operations and reduce fuel consumption.

#### •Power Save Control SUMITOMO UNIQUE DESIGN

Reduces the flow rate of the main pump when the machine is not in operation, which cuts down unnecessary fuel consumption.

#### •BES (Boom-down Energy Save) SUMITOMO UNIQUE DESIGN

Increases fuel efficiency during boom-down operation.

#### •PTR (Pump Transition Reduction) SUMITOMO UNIQUE DESIGN

Decreases main pump loads to reduce fuel consumption.

#### •Idle Shut Down & Auto Idle

Detects when the machine is not in operation, and automatically stops the engine from idling. Also equipped with Auto Idle, which automatically switches the engine to idle when the operation levers are in neutral position.



## Unparalleled Performance

The Innovative Hydraulic System "SIH:S α" provides a stunning new level of performance on job sites. A fully electronically controlled hydraulic pump enhances engine and pump control, and when combined with SUMITOMO's proprietary Spool Stroke Control (SSC) α, ensures precision control across the entire operating range. The excavator responds exactly as the operator is expecting, with predictable speed, digging power and movement streamlining work on any job site.

### Further Enhancements to Working Speed

Advancements and optimisations to the hydraulic system, together with enhanced control valves, have significantly reduced cycle time in all working modes. All these help to boost efficiency on any work site.

**SP mode: 4% faster cycle time**

**H mode: 7% faster cycle time**

**A mode: 5% faster cycle time**

(compared with SH500LHD-6)

### Work Efficiency Drastically Increased SUMITOMO UNIQUE DESIGN

Spool Stroke Control (SSC) α provides precision optimal flow rate control to suit operating conditions. Speed, power, operations, and control are exactly as the operator expects, meaning work efficiency is increased dramatically. It now also covers a greater range, with more precise identification of operating type. These all help to achieve an even higher level of energy efficiency and smooth operations.

### Enhanced Control Valves

The improved valve structure efficiently distributes and supplies hydraulic oil from the pump to actuators, significantly improving work speed for both independent operations and multi-operations.

### Outstanding Speed and Operability

The cycle time speed for loading dump trucks is improved in comparison to the previous SH490LHD-6. The system prioritises fine controls when precision work is required, thus achieving both high volume and delicate operations.





## Advanced Operator Comfort

A comfortable cabin has been designed to reduce operator fatigue, with the aim of relieving stress during work and ensuring greater relaxation during downtime. With features such as a spacious cabin interior, new high-definition monitor with smartphone-like usability, new air suspension seat, and unbelievably quiet operation, the cabin is both comfortable and intuitive to ensure a greater level of safety.

### New Monitor—Even More Intuitive and User-friendly

A wide range of excavator operating and maintenance information, warnings and other data are displayed as text messages. Providing a way to view accurate and easy-to-understand information helps to boost operating efficiency and safety.

#### Illustrations of new monitor displays



#### Indicators

- 1 Working modes
- 2 Icons
- 3 Warning messages
- 4 Engine coolant temperature
- 5 Fuel level
- 6 Urea water level
- 7 ATS warning
- 8 Camera view (rear camera)
- 9 Camera view (right side camera)

#### Switch Panel

- A Travel speed button
- B ATS purge
- C Aux. hydraulic settings
- D Window wiper
- E Window washer
- F Work lights
- G Auto idle/Idle stop
- H Display modes
- I Hour meter toggle (trip/total)

### Spacious, Class-leading Cabin

Just like previous models, the cabin has been designed with features that are top of its class, all of which help to ensure a comfortable and stress-free space for the operator. Superior sound insulation throughout the cabin translates to top-class levels of silence within.

### Console-linked Arm Rest

The arm rest is linked with movement of the tilting console. The distance between the arm rest and operations levers remains the same, regardless of the angle of the console, leading to a greater level of comfort and control.



### New Air Suspension Seat

The operator's seat features air suspension as standard for outstanding ride comfort. A new high-performance reclining seat with higher seatback has been used to ensure premium comfort. A multitude of seat adjustments and ample seat cushion width all help to significantly lower operator fatigue. The high water-repellent seat material is also easier to keep clean.



Seat air suspension

### Premium Comfort with Seat Heater (OPTION)

A seat heater function is now available as an optional extra for even greater comfort in cold seasons or working early mornings. A convenient seat tilting function has also been added that allows the seat cushion to be tilted forward or back to suit the operator's body type or particular job—now anyone can achieve the optimum seating posture for more comfortable control.



Seat heater switch

### Automatic Air-conditioner

Fully automatic climate control maintains a comfortable temperature within the cabin. The optimal ducting layout and airtight cabin also help to boost air-conditioning efficiency.



### Equipment for Comfort and Safety



Rear luggage space

Hot & cool box

Magazine rack

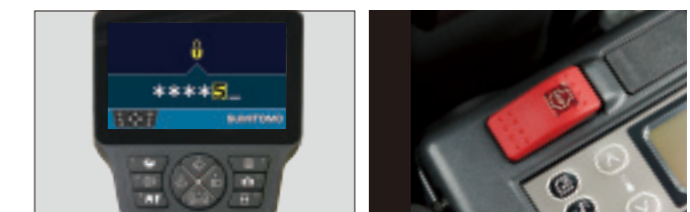

Anti-theft system

Emergency stop switch



## Sophisticated Safety Features

The cabin provides excellent driving visibility, and features a high-strength design to better protect the operator. Every aspect has been designed for day-to-day safety, including excellent access in and out of the cabin, and steps and handrails to make inspections and maintenance easier. The use of rear and right side cameras also helps to ensure operations remain safe.

### Safe ROPS-compliant Cabin

A high-strength cabin design means operators are even better protected.

ROPS: Roll-Over Protective Structure

Moulded steel pipe

Square pipe

Thick plate

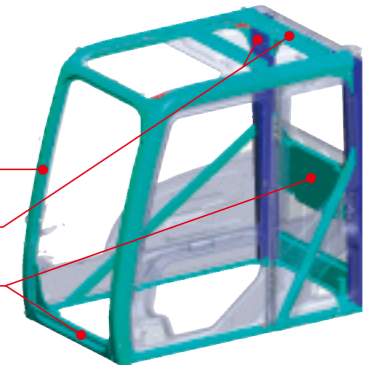

### Wide View for Excellent Site Safety

In addition to the front of the excavator, the cabin design gives the operator a wide, unrestricted view to check upper and lower areas. Direct visibility for the operator means work can be performed safer.



### Superb Access

The wide door opening and large handrails provide excellent access up to and down from the cabin. The spacious footwell also makes it easier to get in and out.



Large handrail and spacious footwell

### Rear and Right Side Cameras

Two cameras are installed as standard—rear view and on the right side—so the operator can check for safety behind the excavator. Optimally positioned mirrors and the use of cameras ensure that mirror visibility meets ISO standards, thus making it easier for the operator to check for safety in any desired direction.



Monitor videos

### Handrails and Non-slip Plates for Operator Safety

Steps and handrails are in the optimal positions to assist getting in and out of the cabin and to ensure safety during inspections and maintenance. New handrails have now also been installed at the rear of the cabin and the right side of the body, while non-slip plates improve safety when it is raining.



Handrails



Non-slip plates



Rear camera



Right side camera

### LED Cabin Top Light (OPTION)

A long-life LED cabin top light is now available as an optional extra. Super bright and with a high-visibility colour, the light enhances safety during night-time operations.



LED cabin top light



## Superior Ease-of-maintenance and Durability

Easy maintenance and durability are the key to excavators that are called upon for ongoing work at job sites. With enhanced durability at every corner and proprietary EMS, outstanding reliability is standard with SUMITOMO excavators—they are designed to be easy to operate and maintain for customers, including features like ground level access and refilling AdBlue®.

### Layout for Ease-of-maintenance

Components requiring inspection are all in a central location, meaning inspections and refilling can be performed without having to climb up onto the excavator.

#### •Increased Cooling Performance

The use of a larger radiator and oil cooler help to increase cooling performance and reliability. It is also easier to clean the dust-proof net.

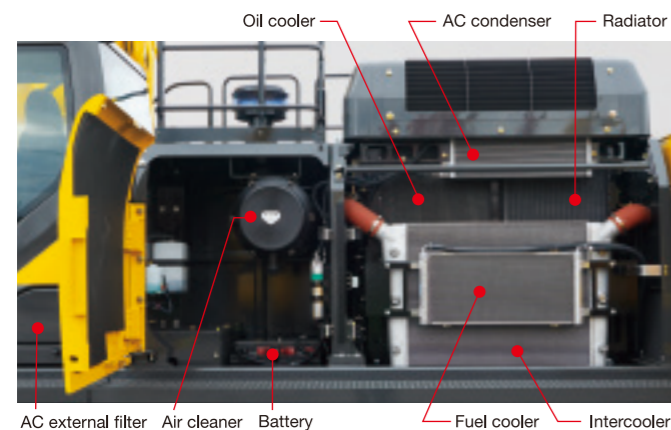

#### •Designed for Easy Filter Replacement

The pre-fuel filter is designed to reduce issues due to a blocked fuel filter, and the easily accessible location of the fuel and oil filters ensure smooth inspection and replacement work.

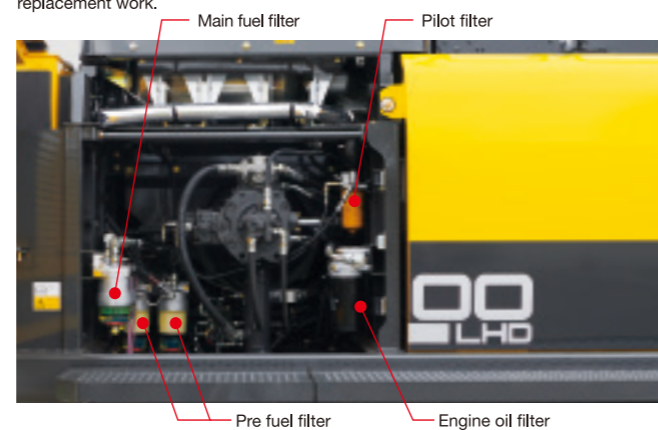

### Battery Cutoff Switch

A battery switch is mounted inside the inspection cover, ensuring safe operations during maintenance procedures.



### Other Maintenance Features



Central fuse box located behind seat



Easy-access AC filter



Washable cab floor and floor mats

### Dust-proof Net and Hydraulically Controlled Reversible Fan System

A dust-proof net mounted in front of the radiator and oil cooler serves to improve reliability. The hydraulically controlled engine cooling fan also achieves optimum cooling performance and reduced noise level. A switch inside the cabin allows airflow to be reversed, which helps to clear clogging caused by dust on the cooling system.

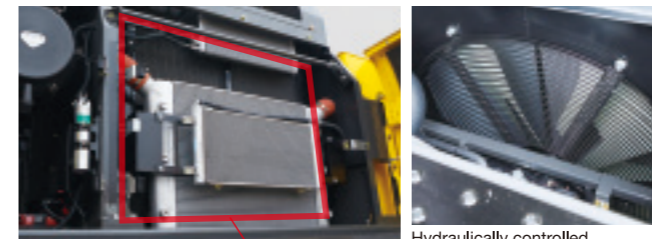

Dust-proof net

Hydraulically controlled Reversible fan system

### High-Performance Return Filter

A long hydraulic oil change interval of 5,000 hours, and the use of a high-performance return filter ensures superior ease-of-maintenance.



Hydraulic oil change: **5,000** hours  
Filter life: **2,000** hours

\* The oil and filter change intervals vary depending on operating conditions.

### Easy-to-fill Urea Tank

The urea tank has been positioned near the front right for easy refilling, to suit the way the excavator is used. In addition to easily refilling water by climbing up on the side frame, water can also be refilled by placing the AdBlue® container in front of the tank.



Urea Tank Capacity: **152 L**  
Refilling frequency: **Once** per **7** refuellings

A large capacity tank has been used for longer refilling intervals and lower the amount of associated work. The tank needs to be refilled around once every seven times the fuel tank is filled (may vary depending on usage conditions).

### Precautions with machines installed with the SCR System

To ensure that the machine can be used safely and smoothly, use AdBlue® aqueous solution (or a urea aqueous solution that complies with ISO standards). Using a non-standard aqueous solution or diluting the solution before use may cause mechanical problems. Malfunctions arising from the use of non-standard aqueous solutions are not covered by SUMITOMO's warranty service.

- The remaining AdBlue® level can be checked during work on the monitor display in the cab. A warning is displayed on the monitor when the remaining level becomes low or there is an issue with quality.
- The engine power output will be limited if the remaining AdBlue® level falls below the minimum level or there is an issue with quality, so be sure to plan refills in advance.

#### Precautions when handling AdBlue®

- The SCR System is designed exclusively for the machine, and must not be used for any other purpose.
- Rinse with water any solution that comes in contact with skin.
- When storing the solution, always use sealed containers and store at room temperature in a well-ventilated location out of direct sunlight. When carrying the solution, always use the container that the solution was purchased in, or other specified container.
- The SCR System includes a heater function, however sufficient care must be taken to prevent freezing when the solution is stored in cold regions (freezing temperature: -11°C).



Example monitor warning display

Read the instruction manual for more details.



# Advances Abound. Innovation Infinite.



## EMS for Enhanced Maintenance of Joints SUMITOMO UNIQUE DESIGN

SUMITOMO's EMS (Easy Maintenance System) has been used to ensure the excavator is always at the forefront of any work site. Special bushes keep joints lubricated and prevent rattling, and help give parts like bushes and pins a longer operating life.

Greasing interval for other sections: **1,000 hours**

\* The greasing interval varies depending on operating conditions.



Attachment EMS bushing with self-lubricating capability

## Higher Rigidity Boom and Arm

The structure of the boom and arm has been further improved, ensuring strength and durability. In addition, high strength castings are used for the boom base and arm end, improving reliability.

### ● Boom

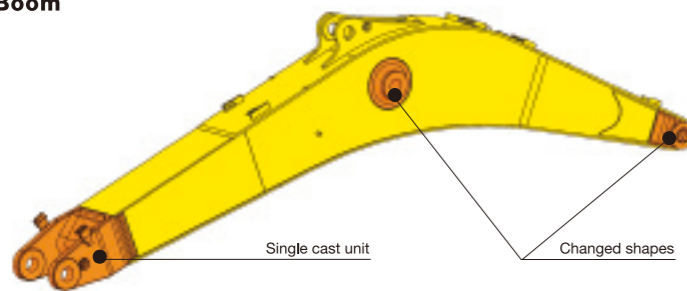

### ● Arm

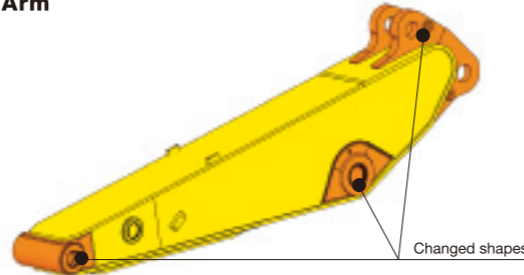

## Superior Undercarriage Cleanout

A linear angled shape for the upper side frame is designed to make it easier to clean out debris from the undercarriage.

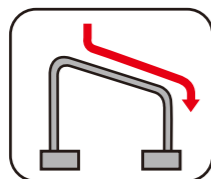

■ Upper side frame shape

Image has been simplified for illustration purposes.

## New Undercarriage with Enhanced Durability and Easier Maintenance

A new undercarriage has been designed for enhanced durability with improvements including enhanced front idlers and a stronger travel motor case. Modified interior sealing also increases sediment resistance.

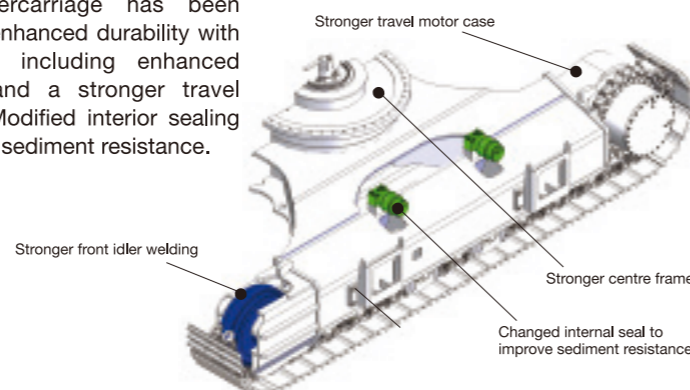

# Specifications

## SH500LHD/SH520LHD-7 Technical Data

The electronic-controlled engine of SPACE 5 α and SIH:S α with New Hydraulic System Includes: three working modes (SP, H and A), one-touch/automatic idling system, automatic power-boost, speed assistance system, power-swing system.

### Engine

SH500LHD/SH520LHD-7	
Model	ISUZU VE-6UZ1X
Type	Water-cooled, 4-cycle diesel, 6-cylinder in line, high pressure common rail system (electric control), turbocharger with air-cooled intercooler, without cooling fan and ATS.
Rated output	270 kW at 2,000 min <sup>-1</sup>
Maximum torque	1,567 N·m at 1,300 min <sup>-1</sup>
Piston displacement	9.839 ltr (9,839 cc)
Bore and stroke	120 mm x 145 mm
Starting system	24 V electric motor starting
Alternator	24 V, 90 A
Air filter	Double element

### Hydraulic pumps

Two variable displacement axial piston pumps provide power for boom/arm/bucket, swing, and travel. One gear pump for pilot controls.

SH500LHD/SH520LHD-7	
Maximum oil flow	2 x 364 ltr/min
Pilot pump max. oil flow	30 ltr/min

### Hydraulic motors

For travel: Two variable displacement axial piston motors  
For swing: One fixed displacement axial piston motor

### Working circuit pressure

Boom/arm/bucket ..... 31.4 MPa  
Boom/arm/bucket with auto power-up ..... 34.3 MPa  
Swing circuit ..... 29.4 MPa  
Travel circuit ..... 34.3 MPa

### Control valve

With boom/arm holding valve  
One 4-spool valve for right track travel, bucket, boom and arm acceleration  
One 5-spool valve for left track travel, auxiliary, swing, boom acceleration and arm

### Oil filtration

Return filter ..... 6 microns  
Pilot filter ..... 8 microns  
Suction filter ..... 105 microns

### Hydraulic cylinders

SH500LHD/SH520LHD-7		
Cylinder	Q'ty	Bore x rod diameter x stroke
Boom	2	170 mm x 115 mm x 1,550 mm
Arm	1	190 mm x 130 mm x 1,920 mm
Bucket	1	170 mm x 115 mm x 1,335 mm

Double-acting, bolt-up-type cylinder tube-end; hardened steel bushings are installed in the cylinder tube and rods ends.

### Cabin & controls

The cabin is mounted on four fluid mountings. Features include safety glass front, rear and side windows, adjustable upholstered suspension seat with headrest and armrest, cigarette lighter, pop-up skylight window, and intermittent wiper with washer. The front window slides upward for storage, and the lower front window is removable. Control levers are located in four positions with tilting control consoles. Built-in type full-colour monitor display. Membrane switch on monitor display.

### Swing

Planetary reduction is powered by an axial piston motor. The internal ring gear with a grease cavity for pinion. The swing bearing is a single-row shear type ball bearing. Dual stage relief valves are used for smooth swing deceleration and stops. A mechanical disc swing brake is included.

SH500LHD/SH520LHD-7	
Swing speed	0-9.1 min <sup>-1</sup>
Tail swing radius	3,730 mm
Swing torque	150 kN·m

### Undercarriage

An X-style carbody is integrally welded for strength and durability. The grease cylinder track adjusters have shock absorbing springs. The undercarriage has lubricated rollers and idlers.

### Type of shoe: sealed link shoe

#### Upper rollers -

Heat treated, mounted on steel bushings with leaded bronze casting, sealed for lifetime lubrication.

#### Lower rollers -

Heat treated, mounted on steel bushings with leaded bronze casting, sealed for lifetime lubrication.

#### Track adjustment -

Idler axles adjusted with grease cylinder integral with each side frame; adjustment yoke mechanism fitted with heavy duty recoil spring.

### Number of rollers and shoes on each side

	SH500LHD-7	SH520LHD-7
Upper rollers	2	3
Lower rollers	9	9
Track shoes	50	50

### Travel system

Two-speed independent hydrostatic system with compact axial motors for increased performance. Hydraulic motor powered output shaft coupled to a planetary reduction unit and track sprocket. All hydraulic components mounted within the width of side frame. Travel speed can be selected by the switch panel on the monitor display. Hydraulically released disc parking brake is built into each motor.

SH500LHD/SH520LHD-7		
Travel speed	High	5.3 km/h
	Low	3.2 km/h
Drawbar pull		339 kN

### Lubricant & coolant capacity

SH500LHD/SH520LHD-7	
Hydraulic system	460 ltr
Hydraulic oil tank	247 ltr
Fuel tank	650 ltr
Cooling system	55 ltr
Final drive case (per side)	15 ltr
Swing drive case	10.5 ltr
Engine crank case (with remote oil filter)	41 ltr
Urea water tank	152 ltr

### Auxiliary hydraulic system

SH500LHD/SH520LHD-7			
Auxiliary piping type (option)	For Breaker	For Double (breaker & crusher) acting	For D/A + Second option line
Arm type	HD	HD	HD
Bucket linkage type	HD	HD	HD
Auxiliary hydraulic pump flow	364 ltr/min	728 ltr/min	728+65 ltr/min

# Specifications

## Bucket

Options and specifications may differ depending on countries and regions

Model	SH500LHD-7		SH520LHD-7	
Bucket capacity (ISO/SAE/PCSA heaped)	2.9 m <sup>3</sup>	3.1 m <sup>3</sup>	2.9 m <sup>3</sup>	3.1 m <sup>3</sup>
Bucket type	HD ROCK	HD ROCK	HD ROCK	HD ROCK
Number of teeth	6	6	6	6
Width	With side cutter Without side cutter		With side cutter Without side cutter	
Weight	2,830 kg	2,910 kg	2,830 kg	2,910 kg
Combination	2.53 m arm			

○ Suitable for materials with density up to 1,800 kg/m<sup>3</sup> or less

○ Suitable for materials with density up to 1,600 kg/m<sup>3</sup> or less

● Standard bucket (Suitable for materials with density up to 1,800 kg/m<sup>3</sup> or less)

## Weight & Ground Pressure

Model	SH500LHD-7			
Shoe type	Shoe width	Overall width	Operating weight	Ground pressure
Triple grouser shoe	600 mm	3,590 mm	50,800 kg	87 kPa

Model	SH520LHD-7			
Shoe type	Shoe width	Overall width	Operating weight	Ground pressure
Triple grouser shoe	600 mm	3,700 mm	52,100 kg	89 kPa

## Digging Force

Model	SH500LHD/SH520LHD-7
Arm length	2.53 m
Bucket digging force (with auto power up)	274 kN (300 kN)
Arm digging force (with auto power up)	240 kN (263 kN)

## Lifting Capacity

- Notes: 1. Ratings are based on ISO 10567  
 2. Lifting capacity does not exceed 75% of tipping load with the machine on firm, level ground or 87% full hydraulic capacity.  
 3. The load point is arm top.  
 4. \*Indicates load limited by hydraulic capacity.  
 5. 0 m = Ground.

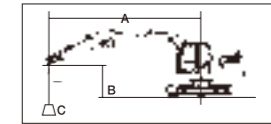

Unit: kg

## SH500LDH-7

SHOE : 600 (mm) G  
 MAXIMUM REACH : 8.96 (m)  
 ARM LENGTH : 2.53 (m)  
 COUNTERWEIGHT : 10,000 kg  
 BOOM : 6.55 (m)

Arm Top Height	Max. Radius		Radius of Load															
	(kg)	(m)	8 m	7 m	6 m	5 m	4 m	3 m	Min. Radius		(kg)	(m)	(kg)	(m)				
7 m	13 050*	7.60	11 080	7.60			13 240*	12 730	14 000*	14 000*					14 010*	5.99	14 010*	5.99
6 m	12 780*	8.14	9 820	8.14	12 820*	10 120	13 520*	12 550	14 700*	14 700*					15 820*	5.32	15 820*	5.32
5 m	12 630*	8.53	9 010	8.53	13 000*	9 990	14 080*	12 260	15 710*	15 440	18 260*	18 260*	22 730*	22 730*	23 300*	3.91	23 300*	3.91
4 m	12 550*	8.79	8 480	8.79	13 340*	9 800	14 750*	11 910	16 860*	14 870	20 250*	19 330			23 120*	4.46	22 810	4.46
3 m	12 520*	8.93	8 160	8.93	13 700*	9 580	15 410*	11 570	17 930*	14 330	21 960*	18 450			23 500*	4.73	19 920	4.73
2 m	12 480	8.95	8 030	8.95	13 970*	9 390	15 920*	11 270	18 700*	13 900	22 950*	17 830			24 200*	4.77	19 020	4.77
1 m	12 520*	8.86	8 060	8.86	14 070*	9 240	16 180*	11 040	19 040*	13 590	23 110*	17 500			20 390*	4.60	19 770	4.60
0 m	12 500*	8.65	8 280	8.65	13 870*	9 150	16 090*	10 900	18 910*	13 420	22 630*	17 370			17 930*	4.18	17 930*	4.18
-1 m	12 410*	8.32	8 720	8.32	13 220*	9 140	15 570*	10 860	18 280*	13 370	21 600*	17 370	24 380*	24 380*	16 760*	3.41	16 760*	3.41
-2 m	12 190*	7.84	9 480	7.84			14 470*	10 910	17 080*	13 430	20 020*	17 480	23 130*	23 130*	19 850*	2.46	19 850*	2.46
-3 m	11 710*	7.19	10 770	7.19			12 350*	11 110	15 110*	13 610	17 720*	17 700	20 300*	20 300*	23 470*	2.62	22 410*	2.62
-4 m	10 650*	6.31	10 650*	6.31					11 730*	11 730*	14 320*	14 320*	16 350*	16 350*	22 210*	3.29	17 340*	3.29

## SH520LDH-7

SHOE : 600 (mm) G  
 MAXIMUM REACH : 8.96 (m)  
 ARM LENGTH : 2.53 (m)  
 COUNTERWEIGHT : 10,000 kg  
 BOOM : 6.55 (m)

Arm Top Height	Max. Radius		Radius of Load															
	(kg)	(m)	8 m	7 m	6 m	5 m	4 m	3 m	Min. Radius		(kg)	(m)	(kg)	(m)				
9 m	14 260*	6.03	14 260*	6.03			14 250*	14 250*							14 250*	5.93	14 250*	5.93
8 m	13 440*	6.99	13 440*	6.99											13 700*	6.14	13 700*	6.14
7 m	13 000*	7.69	11 650	7.69			13 260*	13 260*	14 080*	14 080*					14 160*	5.93	14 160*	5.93
6 m	12 750*	8.21	10 390	8.21	12 830*	10 850	13 590*	13 420	14 830*	14 830*					16 400*	5.14	16 400*	5.14
5 m	12 610*	8.58	9 580	8.58	13 040*	10 710	14 170*	13 110	15 880*	15 880*	18 560*	18 560*			23 220*	4.02	23 220*	4.02
4 m	12 540*	8.82	9 060	8.82	13 390*	10 510	14 850*	12 760	17 030*	15 940	20 530*	20 530*			23 150*	4.52	23 150*	4.52
3 m	12 520*	8.94	8 770	8.94	13 750*	10 290	15 500*	12 420	18 070*	15 400	22 160*	19 890			23 580*	4.75	21 380	4.75
2 m	12 520*	8.94	8 650	8.94	14 000*	10 100	15 980*	12 130	18 780*	14 980	23 020*	19 320			23 920*	4.76	20 710	4.76
1 m	12 520*	8.84	8 720	8.84	14 060*	9 950	16 190*	11 910	19 060*	14 690	23 080*	19 020			19 920*	4.55	19 920*	4.55
0 m	12 490*	8.61	8 990	8.61	13 810*	9 870	16 040*	11 780	18 850*	14 540	22 510*	18 900			17 670*	4.09	17 670*	4.09
-1 m	12 390*	8.26	9 510	8.26	13 070*	9 880	15 450*	11 750	18 140*	14 500	21 400*	18 920	24 910*	24 910*	16 700*	3.25	16 700*	3.25
-2 m	12 140*	7.75	10 400	7.75			14 240*	11 820	16 840*	14 580	19 730*	19 050	22 760*	22 760*	24 740*	2.46	21 390*	2.46
-3 m	11 590*	7.07	11 590*	7.07			11 860*	11 860*	14 720*	14 720*	17 300*	17 300*	19 790*	19 790*	21 620*	2.68	21 830*	2.68
-4 m	10 400*	6.15	10 400*	6.15					10 960*	10 960*	13 650*	13 650*	15 610*	15 610*	16 340*	3.48	16 340*	3.48

## Working Range

	SH500LHD-7	SH520LHD-7
Arm length	2.53 m	2.53 m
Boom length	6.55 m	6.55 m
A Max digging radius	10,910 mm	10,910 mm
B Max digging depth	6,600 mm	6,450 mm
C Max digging height	10,600 mm	10,750 mm
D Max dumping height	7,050 mm	7,200 mm
E Max vertical wall cut depth	4,440 mm	4,290 mm
F Min front swing radius	4,590 mm	4,590 mm
G Rear end swing radius	3,730 mm	3,730 mm

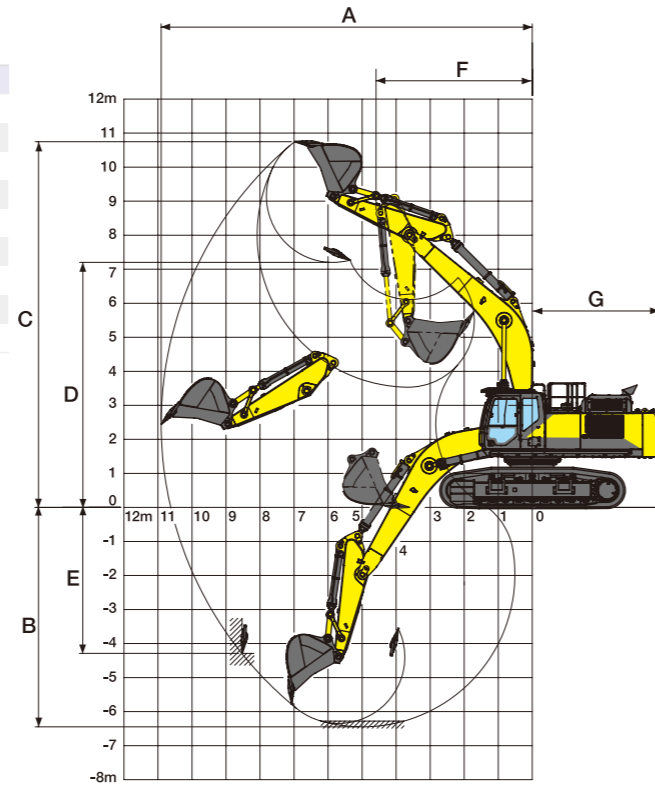

## Principle Specifications

	SH500LHD-7	SH520LHD-7
	STD Specifications	
Base	Boom length 6.55 m Arm length 2.53 m Bucket capacity (ISO heaped) 2.9 m <sup>3</sup> Std. operating weight 50,800 kg / 52,100 kg	
Engine	Make & model ISUZU VE-6UZ1X Rated output (SAE J1349) 270 kW/2,000 min <sup>-1</sup> Displacement 9.839 ltr	
Hydraulic System	Main pump 2 variable displacement axial piston pumps with regulating system Max pressure 31.4 MPa /with auto power boost 34.3 MPa Travel motor Variable displacement axial piston motor Parking brake type Mechanical disc brake Swing motor Fixed displacement axial piston motor	
Performance	Travel speed 5.3/3.2 km/h Drawbar pull 339 kN Gradeability 70% (<35°) Ground pressure 87 kPa / 89 kPa Swing speed 9.1 min <sup>-1</sup> Bucket digging force (ISO 6015) 274 kN /with auto power boost 300 kN Arm digging force 240 kN /with auto power boost 263 kN	
Others	Fuel tank 650 ltr Hydraulic fluid tank 247 ltr Urea water tank 152 ltr	

## Standard Equipment

### [Hydraulic system]

- SIH:S a hydraulic system
- Operation mode (SP, H and A mode)
- Automatic 2-speed travel
- Automatic power boost
- Boom/arm holding valve
- Arm/boom reactivation circuit
- Automatic swing parking system
- Auxiliary valve
- High-performance return filter
- Hydraulic drive cooling fan

### [Cabin/interior equipment]

- Shock-less cab suspension with 4-point fluid mounts
- New full-colour LCD monitor
- Tilting console
- Fresh-air intake pressurised full-automatic air conditioner
- Defroster
- Hot & cool box
- High water-repellent seat
- Seat suspension
- Armrest & headrest
- Windscreen wiper (with intermittent operation function)
- Cup holder
- Magazine rack
- Accessory case
- Floor mat
- Ashtray & cigarette lighter
- Cab light (Auto-OFF function)
- Coat hook
- Operation lever with one-touch wiper switch
- Polycarbonate roof top window with sunshade
- 12V power (DC-DC converter)

### [Safety equipment]

- ROPS cab (FOPS level 1)
- Head guard (OPG Level 2)
- Rear/right side camera
- Rearview mirror (left/right)
- Emergency escape tool
- Retracting seat belt
- Gate lock lever (engine neutral start)
- Travel alarm
- Anti-theft alarm system
- Engine room firewall
- Fan guard
- Engine emergency stop switch

### [Others]

- Auto/one-touch idling
- Auto idle shutdown system
- EMS
- Long-life hydraulic oil
- Five lights (chassis, left/right of boom, cab)
- Fuel filter (with water separator and clogging sensor)
- Fuel pre-filter (with water separator)
- Double-element air cleaner
- Grease-enclosed track link
- Large tool box
- A set of tools
- Pre-air cleaner
- Catwalk

## Accessories (option)

### ■ Cab-top lights (LED)



### ■ Camera lights (LED) (top: side, bottom: rear)



### ■ Rain deflector



### ■ Sun visor



### ■ Front mesh guard (full)



### ■ Front guard (OPG level 1 or 2)



### ■ Refuel pump

### ■ Hose burst check valve (HBCV) for boom/arm cylinders

Accessories and specifications may differ depending on countries and regions.

## Dimensions

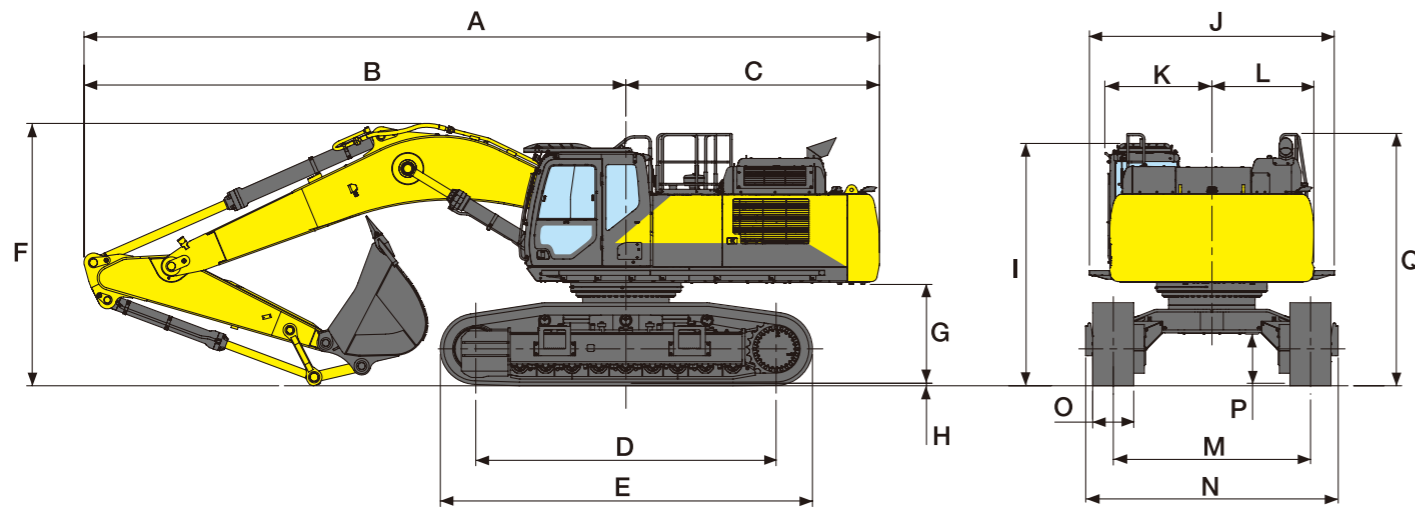

Model	SH500LHD-7	SH520LHD-7
Arm length	2.53 m	2.53 m
<b>A</b> Overall length	11,680 mm	11,660 mm
<b>B</b> Length from centre of machine (to arm top)	7,960 mm	7,940 mm
<b>C</b> Length from centre of machine (to rear end)	3,720 mm	3,720 mm
<b>D</b> Centre to centre of wheels	4,400 mm	4,400 mm
<b>E</b> Overall track length	5,450 mm	5,450 mm
<b>F</b> Overall height	3,790 mm	3,840 mm
<b>G</b> Clearance height under upper structure	1,300 mm	1,450 mm
<b>H</b> Shoe lug height	36 mm	36 mm
<b>I</b> Cab height	3,400 mm	3,550 mm
<b>J</b> Upper structure overall width (with cat walk)	3,590 mm	3,590 mm
<b>K</b> Width from centre of machine (left side)	1,570 mm	1,570 mm
<b>L</b> Width from centre of machine (right side)	1,490 mm	1,490 mm
<b>M</b> Track gauge (retract)	2,750 mm	2,890 (2,390) mm
<b>N</b> Overall width (retract)	3,560 mm	3,700 (3,200) mm
<b>O</b> Std. shoe width	600 mm	600 mm
<b>P</b> Minimum ground clearance	535 mm	720 mm
<b>Q</b> Overall height (to top of handrail)	3,550 mm	3,700 mm

### ● Boom

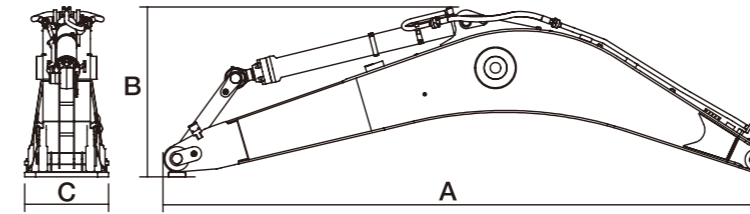

### ● Boom cylinder

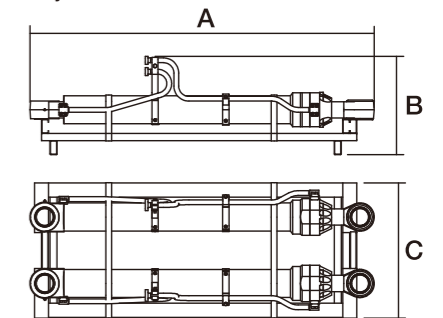

### ● Arm

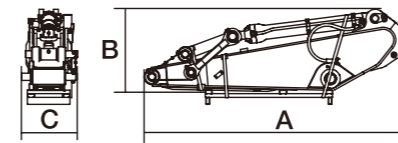

### ● Bucket

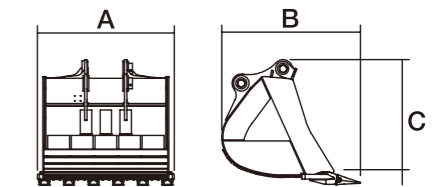

### ● Counterweight

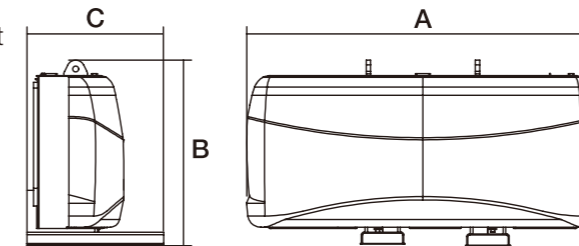

### Boom

Model	SH500LHD/SH520LHD-7
Type	6.55 m Boom
<b>A</b>	6,820 mm
<b>B</b>	1,920 mm
<b>C</b>	950 mm
Weight	4,710 kg

### Boom cylinder

Model	SH500LHD/SH520LHD-7
<b>A</b>	2,440 mm
<b>B</b>	700 mm
<b>C</b>	950 mm
Weight	880 kg

### Arm

Model	SH500LHD/SH520LHD-7
Type	2.53 m Arm
<b>A</b>	3,830 mm
<b>B</b>	1,350 mm
<b>C</b>	790 mm
Weight	2,610 kg

### Bucket

Model	SH500LHD/SH520LHD-7	
Bucket capacity (ISO/SAE/PCSA heaped)	2.9 m <sup>3</sup>	3.1 m <sup>3</sup>
Type	Rock	Rock
<b>A</b>	1,940 mm	2,020 mm
<b>B</b>	1,960 mm	1,960 mm
<b>C</b>	1,770 mm	1,770 mm
Weight	2,850 kg	2,930 kg

### Counterweight

Model	SH500LHD/SH520LHD-7
<b>A</b>	2,990 mm
<b>B</b>	1,570 mm
<b>C</b>	1,160 mm
Weight	10,200 kg